

SOFTENER ASSY RF0835CABCI, CABINET TYPE W/O MEDIA, 1" CI VALVE

SET OF EQUIPMENT

- CI 1" control valve¹
- Pressure tank 08x35, 2,5"²
- Cabinet assembly³

¹CI 1" valve assembly (V1CIDM):

- CI 1" control valve
- Top stack distributor, 11 segments
- Connection kit 3/4"
- Power supply
- Injector, DLFC - for Ecomix and cation exchange resin

²Pressure tank assembly:

- Pressure tank 08x35, 2,5"
- Riser
- Bottom stack distributor

³Cabinet assembly

- Top and bottom cabinet parts (blue)
- Brine well assembly (brine valve, overflow set)



KEY FEATURES

- Ready sets for different filtration medias
- Basic set ready to work with Ecomix and cation exchange resin*
- Overflow protection of the brine tank
- The set is designed for convenient and quick installation
- Compact dimensions

CI CONTROL VALVE KEY FEATURES

- Regeneration control by water volume: delayed regen, immediate, both
- Possibility to change the cycle of regeneration stages and their range of time
- Program in ppm, French degrees, German degrees, or cubic meters
- Stores system configuration and operation data in nonvolatile memory
- Different setting modes are available:
 - Twin or duplex configurations
 - Up to 6 systems to the system controller

PHYSICAL PARAMETERS

Inlet, outlet	G 1"
Drine	G 1"
Brine line	G 3/8"
Operating pressure	2 - 6 bar
Operating temperature	+4...+30 °C
Electrical requirements	230 V, 50 Hz
Electrical power	30 W
Volume of pressure tank	25 L
The volume of the rounded side	1,5 L
Dry system weight	10 kg

Softener assy w/o media, 1" CI valve

Code	Product	Water flow rate**	
		Service, m ³ /h (pressure drop 1 bar)	Backwash, m ³ /h (pressure drop 1,7 bar)
RF0835CABCI	Softener assy RF0835CABCI, cabinet type w/o media	6,12	6,12

*For operation with another filter media just need to change the DLFC and injector

**Only for Clack WS1 CI control valves includes meter, bypass, and 3/4" fitting kit

ACCESSORIES**

Code	Description
V3006	WS1 Bypass Assembly
V3009	WS1 Auxiliary Microswitch Assembly
V3070FM	Bypass shut-off valve during regeneration (no-Bypass valve) for 1" and 1.25" systems
V3069MM-01	Water Specialist 1" & 1.25" Motorized Alternating Valve
V3191-01	WS1 Bypass Vertical Adapter Assy

** Not included in the basic set.
Can installed as additional equipment

RECOMMENDED MEDIA VOLUME

Code	Description	Volume
ECOMIXC25	Ecomix Type C filter media, 25 L bag	18 L
ECOMIXA25	Ecomix Type A filter media, 25 L bag	18 L
ECOMIXP25	Ecomix Type P filter media, 25 L bag	18 L
HCRSS	Strong acid cation exchange resin HCRS-S	18 L
PC002	Strong acid cation exchange resin PC002	18 L

The volume of filter material depends on the its characteristics.
TDS on filter materials can be found on the official website www.ecosoft.com.

CONNECTIONS

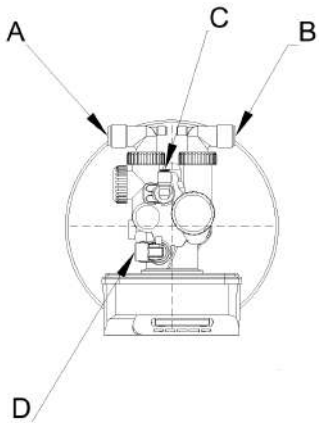

Marking	Nomenclature	Connection	Height
A	Outlet	PH G 3/4"	930±30
B	Inlet	PH G 3/4"	930±30
C	Brine line	PH G 3/8"	1020±30
D	Drain	PH G 3/4"	1030±30

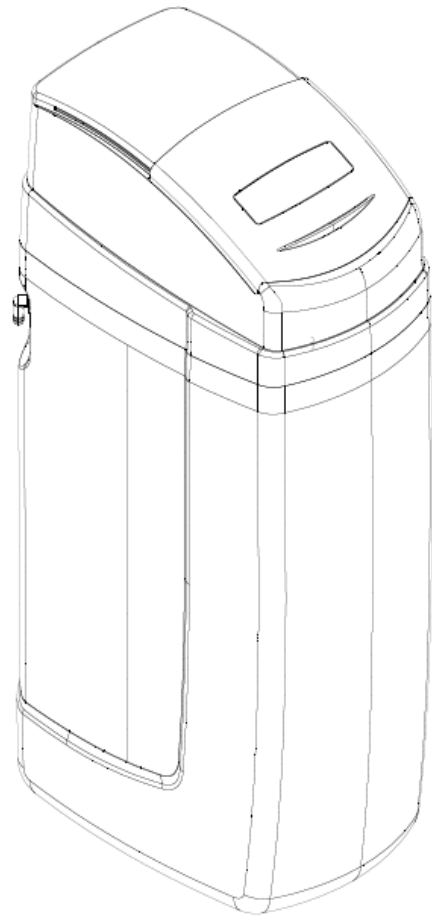

DIMENSIONS OF SYSTEM

