

Water Specialist CE Control Valve Programming Manual

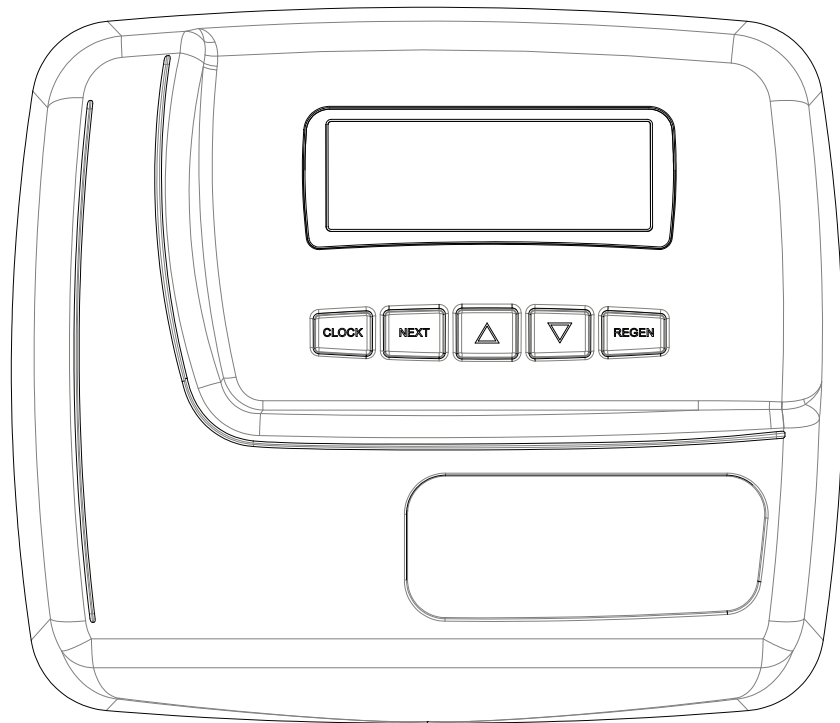

Table of Contents

Front Cover and Drive Assembly	4
OEM General Programming Instructions	5
OEM System Setup	8
OEM Configuration Setup	10
Setting Options Table	16
Installer Display Settings	17
User Display Settings	18
Diagnostics	21
Valve History	23

Front Cover and Drive Assembly

Drawing No.	Order No.	Description	Quantity
1	V3984-01	WS1CD FRONT COVER ASSEMBLY	1
2	V3107-01	WS1 MOTOR ASY	1
3	V3002-A	WS1 DRIVE BRACKET ASY	1
4	V3985CE-02BOARD	WS1 THRU 2 CE2 PCB REPLACE	1
5	V3110	WS1 DRIVE REDUCING GEAR 12X36	3
6	V3109	WS1 DRIVE GEAR COVER	1
Not Shown	V3186EU-06	WS1 POWER SUPPLY EU 15VDC HOCP	1
Not Shown	V3946	WS1 WIDE DRIVE BACK PLATE	1

Refer to Control Valve Service Manual for other drawings and part numbers.

Relay Driver Output Type – Dual Solid-State 12VDC “wet” contacts - N.O.
 Relay Driver Output Capacity - 12VDC @100mA per relay output (total current through both outputs not to exceed 200mA).

Power Supply	U.S.
Supply Voltage	100-120 VAC
Supply Frequency	50/60 Hz
Output Voltage	15 VDC
Output Current	500 mA

NOTE: Check for proper mounting dimensions on valve back plate prior to mounting an external relay under control cover.

Wiring For Correct On/Off Operation	
PC Board Relay Terminal Block	Relay
RLY 1	Coil -
+ COM	Coil +
RLY 2	Coil -

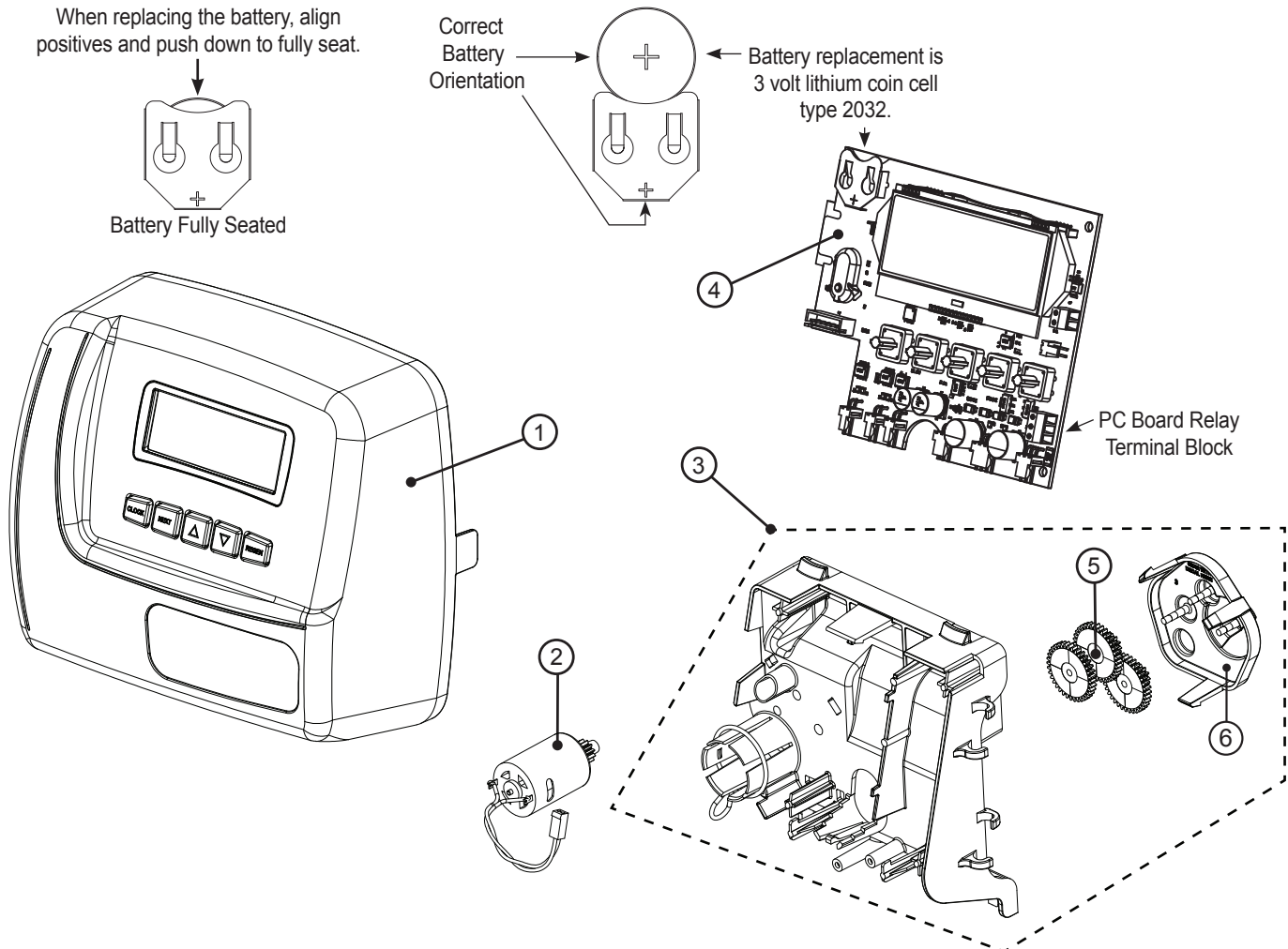

OEM General Programming Instructions

The control valve offers multiple procedures that allow the valve to be modified to suit the needs of the installation. These procedures are:

- OEM System Setup
- OEM Configuration Setup
- User Display Settings
- Diagnostics
- Valve History
- Installer Display Settings

Once the OEM System has been set up, the other procedures can be accessed in any order. Details on each of the procedures are provided on the following pages.

To “lock out” access to diagnostic and valve history displays and modifications to settings except hardness, day override, time of regeneration and time of day by anyone but the manufacturer, press ▼, NEXT, ▲, and CLOCK in sequence after settings are made. To “unlock”, so other displays can be viewed and changes can be made, press ▼, NEXT, ▲, and CLOCK in sequence.

When in operation normal user displays such as time of day, volume remaining before regeneration, present flow rate or days remaining before regeneration are shown. When stepping through a procedure, if no buttons are pressed within five minutes, the display returns to a normal user display. Any changes made prior to the five minute time out are incorporated.

To quickly exit OEM programming screens, Diagnostics or Valve History press CLOCK. Any changes made prior to the exit are incorporated.

To clear the Service Call reminder, press ▲ and ▼ simultaneously while Scheduled Service is displayed.

When desired, all programming and information in Diagnostics may be reset to defaults when the valve is installed in a new location. To reset to defaults, press NEXT and ▼ simultaneously to go to the AUTO/MANUAL screen. Press ▲ and ▼ simultaneously to reset programming and diagnostic values to defaults. Screen will return to User Display.

Sometimes it is desirable to have the valve initiate and complete two regenerations within 24 hours and then return to the preset regeneration procedure. It is possible to do a double regeneration if the control valve is set to “DELAYED REGEN” or “BOTH”.

To do a double regeneration:

1. Press the REGEN button once. “REGEN TODAY” will flash on the display.
2. Press and hold the REGEN button for three seconds until the valve regeneration initiates.

Once the valve has completed the immediate regeneration, the valve will regenerate one more time at the preset regeneration time.

For Valve Type 1.0TWIN, press and hold CLOCK and ▲ for about 3 seconds to initiate an exchange of the tank in Service without cycling the regeneration valve. After tank switch, days remaining and capacity remaining status is retained for each tank until the next regeneration.

Proportional Brining

If the system is set up as a prefill upflow softener, the control valve can also be set to normal or proportional brining.

Prior to selecting the upflow regeneration cycle, verify that the correct body, main piston, regenerant piston and stack are being used, and that the injector plug(s) are in the correct location. Refer to the Service Manual for drawings and part numbers.

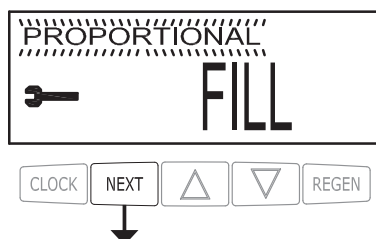

This step will appear after Step 7SS and before Step 8SS if the system is set up as a prefill upflow softener. The following options can be selected:

- NORMAL FILL - System always prefills with the salt level selected.
- PROPORTIONAL FILL - If proportional brining is selected, the actual salt fill time will be calculated by dividing the actual volume of treated water used by the full volumetric capacity, then multiplying this value by the maximum salt fill time.

The control valve's unique design and electronics allows the OEM to select AUTO or MANUAL mode for programming. Cycles can also be fine-tuned when mode is set to AUTO.

Table 1 – Program Parameters with Mode set to “AUTO SETUP”									
System Type	Media Volume (L)	Softening Capacity (meq/l)	Softening Capacity (PPM)	Softening Capacity (dH)	BW (min) Downflow only	Brine Draw (min)	2 nd BW (min)	Rinse (min)	Fill (kg)
ECOMIX	8	5.6	0.28	15.74	10	45	1	5	0.8
ECOMIX	12	8.4	0.42	23.60	10	45	1	5	1.2
ECOMIX	18	12.6	0.63	35.41	10	45	1	10	1.8
ECOMIX	25	17.5	0.88	49.18	10	60	1	10	2.5
ECOMIX	37	25.9	1.30	72.78	15	60	1	10	3.7
ECOMIX	50	35.0	1.75	98.35	15	60	1	10	5.0
ECOMIX	62	43.4	2.17	121.95	15	60	1	10	6.2
ECOMIX	75	52.5	2.63	147.53	15	60	1	10	7.5
ECOMIX	100	70.0	3.50	196.70	15	60	1	10	10.0
ECOMIX	125	87.5	4.38	245.88	15	60	1	10	12.5
SOFTENER	8	9.6	0.48	26.98	10	45	1	5	0.8
SOFTENER	12	14.4	0.72	40.46	10	45	1	5	1.2
SOFTENER	18	21.6	1.08	60.70	10	45	1	10	1.8
SOFTENER	25	30.0	1.50	84.30	10	60	1	10	2.5
SOFTENER	37	44.4	2.22	124.76	10	60	1	10	3.7
SOFTENER	50	60.0	3.00	168.60	10	60	1	10	5.0
SOFTENER	62	74.4	3.72	209.06	10	60	1	10	6.2
SOFTENER	75	90.0	4.50	252.90	10	60	1	10	7.5
SOFTENER	100	120.0	6.00	337.20	10	60	1	10	10.0
SOFTENER	125	150.0	7.50	421.50	10	60	1	10	12.5
FILTER	NA	NA	NA	NA	8	NA	NA	4	NA

Table 2 – CYCLE SEQUENCE with Mode set to “AUTO SETUP”										
Type	Fill	Service	BW	Rinse*	Draw	BW	Rinse	BW*	Fill	Fill*
SOFTENING, DOWNFLOW, POST FILL			X		X	X	X		X	
SOFTENING, DOWNFLOW, PRE-FILL	X	240	X		X	X	X			0:05
SOFTENING, UPFLOW, POST FILL				0:15	X	X	X		X	
SOFTENING, UPFLOW, PRE-FILL	X	240		0:15	X	X	X			0:05
FILTERING, DOWNFLOW, POST FILL			X				X			

*Cycles are non-adjustable, not shown in cycle sequence programming, and are in seconds.
ECOMIX has the same cycle sequence as SOFTENING.

Table 3 – Regeneration Cycle Step Adjustments						
Cycle	Configuration: Set cycle (manual only)	Configuration: Set cycle time	Units	Range*	Increments	Default (manual only)
Backwash	BACKWASH	BACKWASH TIME	MIN	1-30 30-120	1 2	8
Rinse	RINSE	RINSE TIME	MIN	1-30 30-120	1 2	4
Regenerant Draw DN	REGENERANT DRAW DN	DRAW DN TIME	MIN	1-80 80-180	1 2	60
Fill Softening	FILL	FILL	kg	0.05-2.50 2.50-13.5 13.5-55.0 55.0-100.0	0.05 0.25 0.50 1.00	4.25
Fill 1.5” MIN or 2.0” Softening	FILL	FILE TIME	MIN	0.1-10.0 10.0-48.0 48.0-99.0	0.1 0.5 1.0	6
Fill Filtering	FILL	FILL	L	0.2-19.0 19.0-38.0 38.0-76.0	0.2 0.4 0.8	4.20
Softening	N/A	SOFTENING	MIN	1-30 30-480	1 5	240
Regenerant Draw UP	N/A	DRAW UP TIME	MIN	1-80 80-180	1 2	60
Fill 2.0” Filtering	FILL	FILL TIME	MIN	0.1-10.0 10.0-48.0 48.0-99.0	0.1 0.5 1.0	6

*All cycles maybe set to OFF

OEM System Setup

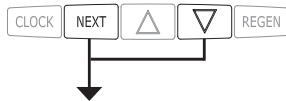
STEP 1SS

Step 1SS – Press NEXT and ▼ simultaneously for about 5 seconds and release. If the screen in Step 2SS does not appear, the lock on the valve is activated. Press ▼, NEXT, ▲ and CLOCK in sequence, then press NEXT and ▼ simultaneously for about 5 seconds and release.

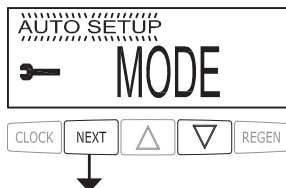
STEP 2SS

Step 2SS – System Setup Mode – Choose between AUTO and MANUAL setup. For AUTO settings, refer to Tables 1 and 2 for available cycle sequences and setting ranges. When MANUAL is selected, cycle order and times can be selected. Press NEXT to go to Step 3SS. Press REGEN to exit System Setup.

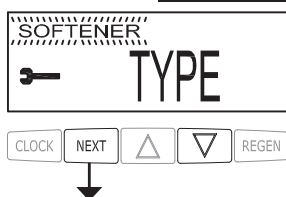
STEP 3SS

Step 3SS – System Type – Choose between SOFTENER, ECOMIX or FILTER. Press NEXT to go to Step 4SS. Press REGEN to return to previous step.

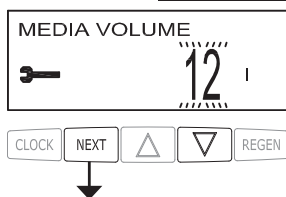
STEP 4SS

Step 4SS – Media Volume – In Auto Setup, when set to Softener or Ecomix, set the volume of system capacity in liters of resin. See Table 1 for available settings. Press NEXT to go to Step 5SS. Press REGEN to return to previous step.

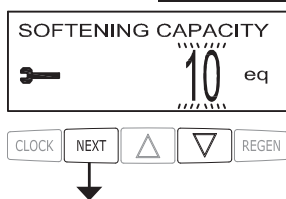
STEP 5SS

Step 5SS – Ionic Capacity – If mode is set to MANUAL, and type is set to SOFTENER or ECOMIX, this amount can be adjusted. If mode is set to AUTO, or type is set to FILTER, this screen will not be viewed. Hardness Units are set in Step 7CS. Press NEXT to go to Step 6SS. Press REGEN to return to previous step.

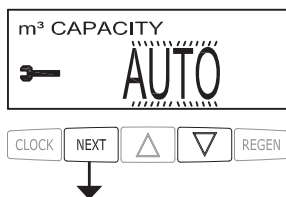
STEP 6SS

Step 6SS – Set Volume Capacity using ▲ or ▼. If value is set to:

- “AUTO” capacity will be automatically calculated and reserve capacity will be automatically estimated;
- “OFF” regeneration will be based solely on the day override set (see Installer Display Settings Step 4I); or
- as a number regeneration initiation will be based off the value specified.

If “OFF” or a number is used, hardness display will not be allowed to be set in Installer Display Settings Step 3I. See Setting Options Table for more details. Press NEXT to go to Step 7SS. Press REGEN to return to previous step.

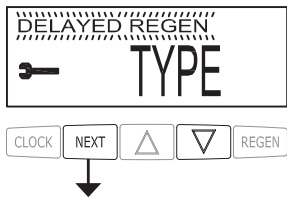
STEP 7SS

Step 7SS – Set Regeneration Time Options using ▲ or ▼:

- “DELAYED REGEN” means regeneration will occur at the pre-set time;
 - “IMMEDIATE REGEN” means regeneration will occur immediately when the gallons capacity reaches 0 (zero); or
 - “BOTH” means regeneration will occur at one of the following:
 - the preset time when the gallons capacity falls below the reserve or the specified number of days between regenerations is reached, whichever comes first; or
 - after 10 minutes of no water usage when the gallon capacity reaches 0 (zero).
- “DELAYED REGEN” is the default if Step 4CS is set to VALVE A or VALVE B, and “BOTH” is not available. See Setting Options Table for more detail.
 “IMMEDIATE REGEN” is the default if Step 2CS is set to 1.0TWIN, and “BOTH” will not be available.

Press NEXT to go to Step 8SS. Press REGEN to return to previous step.

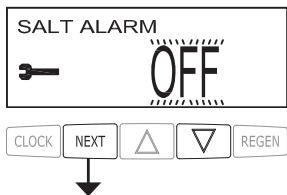
STEP 8SS

Step 8SS – Salt Alarm – Use ▲ or ▼ to set a trigger level for the Salt Alarm. This display is not viewed if System Type is FILTER, Step 6SS is set to OFF, or Valve Type is 2.0 or 1.5 and Step 3CS is set to MIN. Trigger level can be set from 5kg to 200kg in 5kg increments. Press NEXT to go to Step 9SS. Press REGEN to return to previous step.

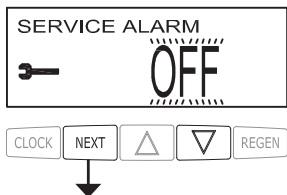
STEP 9SS

Step 9SS – Service Alarm - Set scheduled service alarm using ▲ or ▼. Available options are OFF, TIME, m³ or BOTH.

Selecting OFF disables this feature. If OFF is selected, press NEXT to exit OEM System Setup. If TIME, m³ or BOTH is selected, press NEXT to select the TIME and/or m³ values. Press REGEN to return to the previous step.

**RETURN TO
NORMAL MODE**

NOTE: To clear the Service Call reminder, press ▲ and ▼ simultaneously while the reminder screen is displayed.

OEM Configuration Setup

STEP 1CS

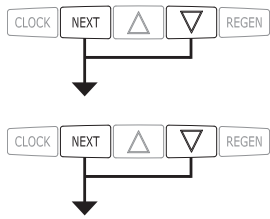

Step 1CS – Press NEXT and ▼ simultaneously for 3 seconds and release. Then press NEXT and ▼ simultaneously for 3 seconds and release. If screen in Step 2CS does not appear in 5 seconds the lock on the valve is activated. To unlock press ▼, NEXT, ▲, and CLOCK in sequence, then press NEXT and ▼ simultaneously for 3 seconds and release. Then press NEXT and ▼ simultaneously for 3 seconds and release.

STEP 2CS

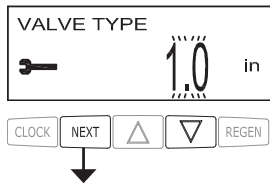

Step 2CS – Use ▲ or ▼ 1.0 for 1” valve, 1.25 for 1.25” valve, 1.5 for 1.5” valve, 2.0 for 2” valve or 1.0TWIN for twin valve. Press NEXT to go to Step 3CS. Press REGEN to exit OEM cycle sequence.

STEP 3CS

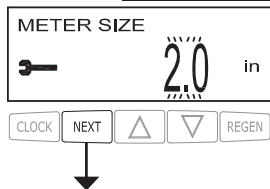

Step 3CS – When 2.0 is selected, an additional screen will appear. It is used to select which size flow meter is to be used with the valve, 1.5, 2.0, 3.0 or 1.0r. Press NEXT to go to Step 4CS. Press REGEN to return to previous step.

STEP 3CSa

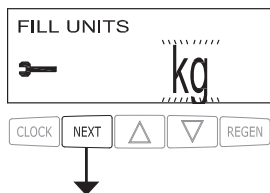

Step 3CSa – Fill Units: If set as a softener, when Step 2CS is set to 1.5 and FILL is part of the Regeneration Cycle Sequence, FILL UNITS of kg or min can be selected. Press NEXT to go to Step 4CS. Press REGEN to return to previous step.



STEP 4CS

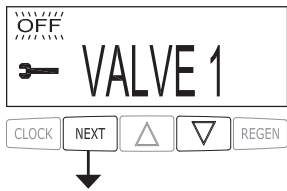

Step 4CS – Allows selection of one of the following using ▲ or ▼:

- the Control Valve to act as an alternator; or
- the Control Valve to have a no hard water bypass; or
- the Control Valve to have a Separate Source during the regeneration cycle; or
- the Control Valve to operate with the Clack System Controller.

Select OFF when none of these features are used.

Only use Clack No Hard Water Bypass Valves or Clack Motorized Alternating Valves (MAV) with these selections. Clack No Hard Water Bypass Valves (1” or 1.25” V3070FF or V3070FM) are not designed to be used with the alternator function or separate source.

This display will not appear if 1.0TWIN is selected in Step 2CS.

Selecting the Control Valve to act as an alternator:

Prior to starting the programming steps, connect the interconnect cable to each control valve board’s three pin connector labeled “COMM CABLE”. Also connect the meter cord to either control valve to the three pin connector labeled “METER”.			
		Softener valve programming steps	
OEM Configuration Setup	Step 4CS	Set to VALVE A Connect the outlet plumbing of Valve A to the MAV’s A port and connect the MAV’s two pin wire connector to the two pin connector labeled MAV 1 on VALVE A	Set to VALVE B Connect the outlet plumbing of VALVE B to the MAV’s B port. No electrical connections are required between the VALVE B valve and the MAV
System Setup	Step 6SS	Set to “AUTO”	Set to “AUTO”
System Setup	Step 7SS	Set regeneration time option to “IMMEDIATE REGEN”.	Set regeneration time option to “IMMEDIATE REGEN”.
Installer Display Setting	Step 5I	Set Day Override to “OFF”	Set Day Override to “OFF”

If set up for a filter, in Step 6SS set Volume Capacity in M³; in Step 7SS select Regeneration Time Option “Immediate”; and in Step 4I select Day Override “OFF”.

For Clack Corporation alternator systems using **WS1, WS1.25 or WS1.5** valves there will be an option to delay the last two cycles of regeneration (only “Rinse” and “Fill”). This feature splits the regeneration into two portions. The first portion of the regeneration will start immediately and all programmed cycles before the “Rinse” and “Fill” cycles will be performed. After all programmed cycles before “Rinse” and “Fill” are completed the control valve will drive to the service position (displaying “Delayed Rinse + Fill Pending”). When the volume of the on-line unit is depleted to 10% of its programmed capacity, the control valve will be triggered to finish the second portion of the regeneration. Once “Rinse” and “Fill” are completed, the valve will re-enter Standby mode until requested to come on-line for Service.

For Clack Corporation alternator systems using the **WS2** valve, when NEXT is pressed after selecting VALVE A or VALVE B, a display will allow the user to set the amount of pre-service rinse time for the stand by tank just prior to returning to service. With 1.0TWIN set, this same display appears and is set in a similar manner.

WS1, WS1.25 and WS1.5 Valves

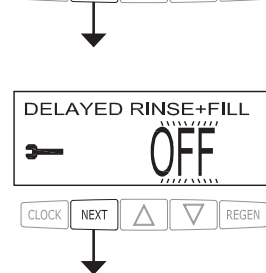

WS2 Valve

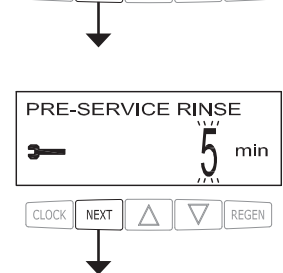

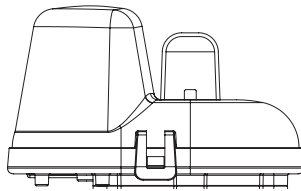
**Retracted**

Valve "A" in Service Position =
MAV piston rod Retracted

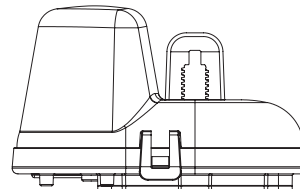
**Extended**

Valve "B" in Service Position = MAV
piston rod Extended

Note: Clack Twin Alternator Operations

- Twin alternating systems can be programmed with a day override setting combined with the normal volume-based regeneration programming. A twin alternating system in this configuration will then regenerate based on the volume used or the day override if there is a period of low water usage.
- Twin alternating systems can be programmed as a time clock only based regenerating system. In this configuration, the days remaining are counted only on the unit that is in service. The unit in Stand-by Mode only notes days in diagnostics, which results in time clock only twin regeneration initiation.
- Twin alternating systems can be programmed for a delayed regeneration time. The system will allow an immediate transfer of the MAV to switch tanks and place a fully regenerated unit in service once a unit becomes exhausted. The exhausted unit will then be placed into Stand-by Mode and allowed to have a delayed regeneration at the pre-set time.

Configuring the Control Valve for No Hard Water Bypass Operation:

Select NO HARD BYPASS for control operation. For no hard water bypass operation the three wire connector is not used. Selection requires that a connection to MAV or a Clack No Hard Water Bypass Valve is made to the two pin connector labeled MAV located on the printed circuit board. If using a MAV, the A port of the MAV must be plugged and the valve outlet connected to the B port. When set to No Hard Bypass the MAV will be driven closed before the first regeneration cycle that is not FILL or SOFTENING or FILTERING, and be driven open once Fill has been reached.

NOTE: If the control valve enters into an error state during regeneration mode, the no hard water bypass valve will remain in its current state until the error is corrected and reset.



Configuring the Control Valve for Separate Source Operation:

Select Separate Source for control operation. For separate source operation, the three wire connector is not used. Selection requires that a connection to a Clack Motorized Alternator Valve (MAV) is made to the two pin connector labeled MAV located on the printed circuit board. The C port of the MAV must be connected to the valve inlet and the A port connected to the separate source used during regeneration. The B port must be connected to the feed water supply.

When set to Separate Source the MAV will be driven closed before the first regeneration cycle, and be driven open after the last regeneration cycle.

NOTE: If the control valve enters into an error state during regeneration mode, the MAV will remain in its current state until the error is corrected and reset.



Configuring the Control Valve to operate with Clack System Controller:

Select System Board Enabled to link the Control Valve to the Clack System Controller. For communication between the Control Valve and the System Controller a three wire communication cable is required.

Press NEXT to go to Step 5CS. Press REGEN to return to previous step.

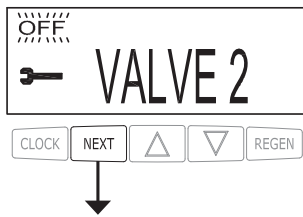

STEP 5CS

Step 5CS – Set Auxiliary Drive Output (MAV only) to operate in one of three modes:

- **TIME** – Output is activated at a set time after the start of regeneration, for a specified length of time.
- **Set SEP SOURCE:** Allows Auxiliary MAV to switch positions before the start of regeneration and then switch back at the end of regeneration.
- **BACKWASH PAUSE:** Output may change state up to 10 times during Backwash. Output activation determined at set times referenced to the start of Backwash, for preset durations of time, not to exceed the total time of the Backwash cycle.
- **Set OFF:** Deactivates this output.

Only use Clack Motorized Alternating Valves (MAV) with these selections. Clack No Hard Water Bypass Valves (1" or 1.25" V3070FF or V3070FM) are not designed to be used with the TIME or SEPARATE SOURCE functions.

Press NEXT to go to Step 6CS. Press REGEN to return to previous step.

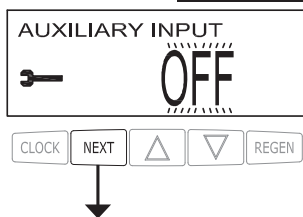
STEP 6CS

Step 6CS – This allows the use of an outside signal to control the initiation of a regeneration. Selection only matters if a connection is made to the two pin connector labeled DP SWITCH located on the printed circuit board. Following is an explanation of the options:

oFF – Feature not used.

NOTE: In a twin alternating system each control must have a separate dP signal or dP switch. One dP signal or one dP switch cannot be used for both controls.

IMMED REG – If the dP switch is closed for an accumulative time of 2 minutes a regeneration will be signaled to the unit. In a twin alternating system the MAV will transition first to switch units so that the signaled unit can start regeneration. After the MAV is fully transitioned the regeneration begins immediately. Note: For WS1 – WS1.5 control valves programmed for twin alternating: if the dP function “IMMED REG” is set, the Delayed Rinse and Fill feature is not available.

DELAY REG – If the dP switch is closed for an accumulative time of 2 minutes a regeneration will occur at the scheduled delayed regeneration time. In a twin alternating system once the dP switch is triggered the PC Board will display “REGEN TODAY” and when the delayed regen time comes the control will switch tanks and the triggered unit will then go into regeneration. Note: For WS1 – WS1.5 control valves programmed for twin alternating: if the dP function “DELAY REG” is set, the Delayed Rinse and Fill feature is not available.

HOLD REG – If the dP switch is closed a regeneration will be prevented from occurring while there is switch closure. In a twin alternating system the regeneration of a unit can be prevented upon switch closure. If the unit depletes the capacity down to zero it will not be allowed to switch tanks to regenerate until the switch is open. Note: For WS1 – WS1.5 control valves programmed for twin alternating the Delayed Rinse and Fill feature can be set in conjunction with the “HOLD REG” if desired.

Press NEXT to go to Step 7CS or to exit Configuration Setup. Press REGEN to return to previous step.

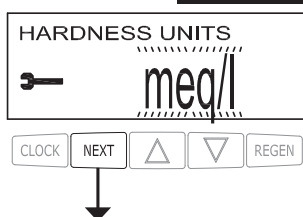
STEP 7CS

Step 7CS – Determine the measurement to calculate volumetric capacity. The choices are:

- PPM parts per million
- Meq/l milliequivalents per liter
- dH German degrees

If type is set to FILTER, this screen will not be viewed.

Press NEXT to go to Step 8CS. Press REGEN to return to previous step.

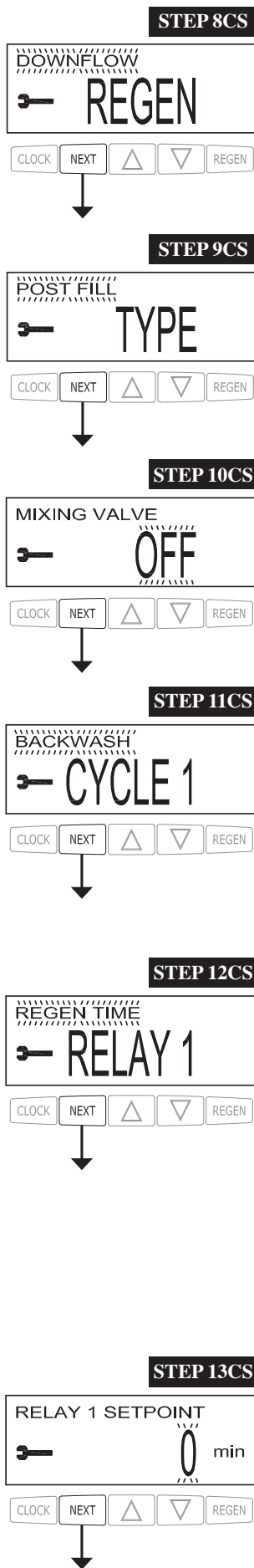

Step 8CS – Regenerant Draw Direction – Select UPFLOW or DOWNFLOW. If mode is set to MANUAL or type is set to FILTER, this screen will not be viewed. Press NEXT to go to Step 9CS. Press REGEN to return to previous step.

Step 9CS – Fill Location – Select POST FILL or PREFILL. If mode is set to MANUAL or type is set to FILTER, this screen will not be viewed. Press NEXT to go to Step 10CS. Press REGEN to return to previous step.

Step 10CS – Mixing Valve Operation – When set to ON, Service Hardness will be viewed and can be set. If type is set to FILTER, or Step 6SS is set to OFF, this screen will not be viewed. Press NEXT to go to Step 11CS. Press REGEN to return to previous step.

Step 11CS – If mode is set to MANUAL, select first regeneration cycle. See Table 3 for available cycles and times. Press NEXT to continue to program all regeneration cycle steps. Press REGEN to return to previous step.

ALTERNATE Step 11CS – If mode is set to AUTO, set the duration of the first regeneration cycle. If mode is set to MANUAL, this screen will be viewed after setting Cycle 1. Press NEXT to continue to program all regeneration cycle steps. Press REGEN to return to previous step.

Step 12CS – Relay 1 Operation – The choices are:

- **REGEN TIME:** Relay activates after a set time at the beginning of a regeneration cycle and then deactivates after a set period of time. The start of regeneration is defined as the first backwash cycle or Regenerant Draw UP or DN, whichever comes first.
- **VOLUME:** Relay activates after a set volume has been used while in service, then deactivates after the meter stops registering flow and the set time period has expired.
- **REGEN VOLUME:** Relay activates after a set volume has been used while in service or during regeneration, then deactivates after the meter stops registering flow and the set time period has expired.
- **ERROR MONITOR:** The relay closes whenever the control enters error mode, and deactivates when error mode is exited.
- **SALT LEVEL:** The relay closes when the salt level is less than the minimum set, and deactivates if the actual salt level is above the minimum level.

Press NEXT to go to Step 13CS. Press REGEN to return to the previous step.

Step 13CS – Relay 1 Setpoint Time or Volume - The choices are:

- **Relay Actuation Time:** After the start of a regeneration the amount of time that should pass prior to activating the relay. The start of regeneration is defined as the first backwash cycle or Regenerant Draw UP or DOWN, whichever comes first. Ranges from 0 to 500 minutes.
- **Relay Actuation Volume or Regen Volume:** Relay activates after a set number of liters have passed. Ranges from 1 to 200 liters.

Press NEXT to go to Step 14CS. Press REGEN to return to previous step.

STEP 14CS

RELAY 1 DURATION
3:00 min

CLOCK NEXT Δ ∇ REGEN

**STEP 15CS**

RELAY 2
VOLUME

CLOCK NEXT Δ ∇ REGEN

**STEP 16CS**

RELAY 2 SETPOINT
1

CLOCK NEXT Δ ∇ REGEN

**STEP 17CS**

RELAY 2 DURATION
3:00 min

CLOCK NEXT Δ ∇ REGEN



RETURN TO NORMAL MODE

Step 14CS – Relay 1 Duration Time – The relay will deactivate after the time set has expired. Ranges from 0:01 to 500:00 minutes. Press NEXT to go to Step 15CS. Press REGEN to return to previous step.

Step 15CS – Relay 2 Operation – The choices are:

- **REGEN TIME:** Relay activates after a set time at the beginning of a regeneration cycle and then deactivates after a set period of time. The start of regeneration is defined as the first backwash cycle or Regenerant Draw UP or DN, whichever comes first.
- **VOLUME:** Relay activates after a set volume has been used while in service, then deactivates after the meter stops registering flow and the set time period has expired.
- **REGEN VOLUME:** Relay activates after a set volume has been used while in service or during regeneration, then deactivates after the meter stops registering flow and the set time period has expired.
- **ERROR MONITOR:** The relay closes whenever the control enters error mode, and deactivates when error mode is exited.

Press NEXT to go to Step 16CS. Press REGEN to return to previous step.

Step 16CS – Relay 2 Setpoint Time or Volume - The choices are:

- **Relay Actuation Time:** After the start of a regeneration the amount of time that should pass prior to activating the relay. The start of regeneration is defined as the first backwash cycle or Regenerant Draw UP or DOWN, whichever comes first. Ranges from 0 to 500 minutes.
- **Relay Actuation Volume or Regen Volume:** Relay activates after a set number of liters have passed. Ranges from 1 to 200 liters.

Press NEXT to go to Step 17CS. Press REGEN to return to previous step.

Step 17CS – Relay 2 Setpoint Time or Volume - The choices are:

- **Relay Actuation Time:** After the start of a regeneration the amount of time that should pass prior to activating the relay. The start of regeneration is defined as the first backwash cycle or Regenerant Draw UP or DOWN, whichever comes first. Ranges from 0 to 500 minutes.
- **Relay Actuation Volume or Regen Volume:** Relay activates after a set number of liters have passed. Ranges from 1 to 200 liters.

Press NEXT to go to Step 17CS. Press REGEN to return to previous step.

Setting Options Table¹

System Type	Regeneration Option	Regeneration Type	Day Override	
Softening	Auto	Delayed	1-28 days	Regeneration occurs at the next regeneration time when volume capacity falls below the reserve capacity, or the specified number of days is reached, whichever comes first.
Softening	Auto	Delayed	OFF	Regeneration occurs at the next regeneration time when volume capacity falls below the reserve capacity.
Softening or Filtering	0.02 – 5700.0 m ³	Delayed	1-28 days	Regeneration occurs at the next regeneration time when volume capacity reaches 0, or the specified number of days is reached, whichever comes first.
Softening or Filtering	0.02 – 5700.0 m ³	Delayed	OFF	Regeneration occurs at the next regeneration time when volume capacity reaches 0.
Softening or Filtering	OFF	Delayed	1-28 days	Time Clock operation. Regeneration occurs at the next regeneration time the specified number of days is reached.
Softening	Auto or 0.02 – 5700.0 m ³	Immediate	1-28 days	Regeneration occurs immediately when volume capacity reaches 0, or the specified number of days is reached, whichever comes first.
Softening or Filtering	0.02 – 5700.0 m ³	Immediate	OFF	Regeneration occurs immediately when volume capacity reaches 0.
Softening	Auto	Both	1-28 days	Regeneration occurs at the next regeneration time when volume capacity falls below the reserve capacity, or the specified number of days is reached, or regeneration occurs after 10 minutes of no water usage when volume capacity reaches 0.
Softening or Filtering	0.02 – 5700.0 m ³	Both	1-28 days	Regeneration occurs at the next regeneration time the specified number of days is reached or regeneration occurs after 10 minutes of no water usage when volume capacity reaches 0.
Softening	Auto	Both	OFF	Regeneration occurs at the next regeneration time when volume capacity falls below the reserve capacity, or regeneration occurs after 10 minutes of no water usage when volume capacity reaches 0.

¹ Reserve Capacity estimate is based on history of water usage. Reserve Capacity estimate is not available with alternator systems or Twin Tank Valve.

Installer Display Settings

STEP 1I

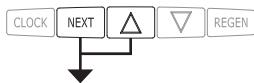

STEP 1I - Press NEXT and ▲ simultaneously for 3 seconds.

STEP 2I

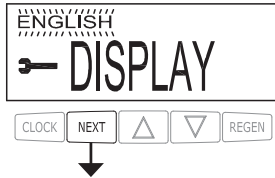

STEP 2I – Display Language – Select between English, German, Ukrainian or Russian. Press NEXT to go to Step 3I. Press REGEN to exit Installer Display Settings.

STEP 3I

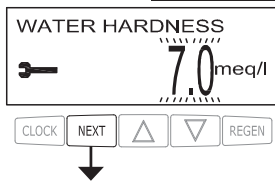

STEP 3I – Hardness: Set the amount of hardness in grains of hardness as calcium carbonate per meq/l, PPM, or dH° using ▼ or ▲. This display will not appear if “FILTERING” is selected in Step 3SS or if OFF or a number is set in Step 9SS. Press NEXT to go to Step 4I. Press REGEN to exit Installer Display Settings.

STEP 4I

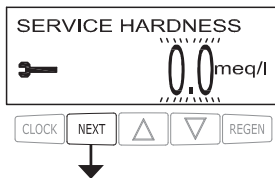

STEP 4I – Service Hardness - This display will only appear if Step 10CS MIXING VALVE is set to ON. Press NEXT to go to Step 5I. Press REGEN to return to previous step.

STEP 5I

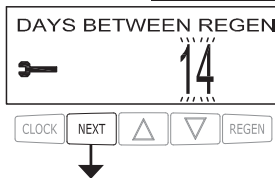

STEP 5I – Day Override: When volume capacity is set to “OFF”, sets the number of days between regenerations. When volume capacity is set to AUTO or to a number, sets the maximum number of days between regenerations. If value set to “OFF”, regeneration initiation is based solely on volume used. If value is set as a number (allowable range from 1 to 28) a regeneration initiation will be called for on that day even if sufficient volume of water were not used to call for a regeneration. Set Day Override using ▼ or ▲:

- number of days between regeneration (1 to 28); or
- “OFF”.

See Setting Options Table for more detail on setup. Press NEXT to go to Step 6I. Press REGEN to return to previous step.

STEP 6I

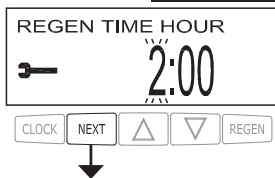

STEP 6I – Next Regeneration Time (hour): Set the hour of day for regeneration using ▼ or ▲. The default time is 2:00. This display will not appear if “IMMEDIATE” is selected in Set Regeneration Time Option in OEM Softener System Setup Step 7SS. Press NEXT to go to Step 7I. Press REGEN to return to previous step.

STEP 7I

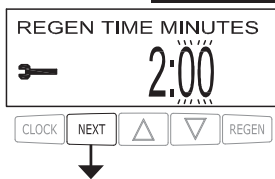

STEP 7I – Next Regeneration Time (minutes): Set the minutes of day for regeneration using ▼ or ▲. This display will not be shown if “IMMEDIATE” is selected in Set Regeneration Time Option in OEM System Setup Step 7SS. Press NEXT to go to Step 8I. Press REGEN to return to previous step.

STEP 8I

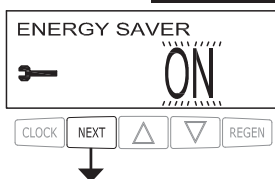

STEP 8I – As an energy-saving feature, the control will automatically turn off the display illumination after 5 minutes of keypad inactivity. Any further keypad activity or water use will re-illuminate the display for 5 minutes. The Energy Saver feature default is ON. Press NEXT to exit Installer Display Settings. Press REGEN to return to previous step.

RETURN TO NORMAL MODE

User Display Settings

General Operation

When the system is operating, one of several displays may be shown. Pressing NEXT will alternate between the displays. One of the displays is always the current time of day. Days to a Regen is the number of days left before the system goes through a regeneration cycle. Pressing ▼ while in the Days Remaining display will decrease the days remaining by 1 day and will also increase the days in operation, impacting the recorded values in Diagnostics Step 2D. Capacity remaining is the volume that will be treated before the system goes through a regeneration cycle. Pressing ▼ while in the Capacity Remaining display will decrease the capacity remaining in .01 cubic meter increments and will also increase the volume used impacting the recorded value in Diagnostics Step 3D. Another display shows the current treated water flow rate through the system. If 1.0TWIN is selected in Step 2CS, an “A” in front of the flow rate indicates the tank with the control valve is in service. If “B” is displayed, the tank with the in/out head is in service. If Auxiliary Input operation is set in Step 6CS, the display will show either dP or HOLD if the dP switch is closed. If Step 9SS is set to show a service alarm, a display indicates the user should call for service. To clear the Service Call reminder, press ▲ and ▼ simultaneously while the service alarm is displayed. If the system has called for a regeneration that will occur at the preset time of regeneration, the words REGEN TODAY will alternate with the header on the display. If a water meter is installed, the flow indicator flashes on the display when water is being treated (i.e. water is flowing through the system).

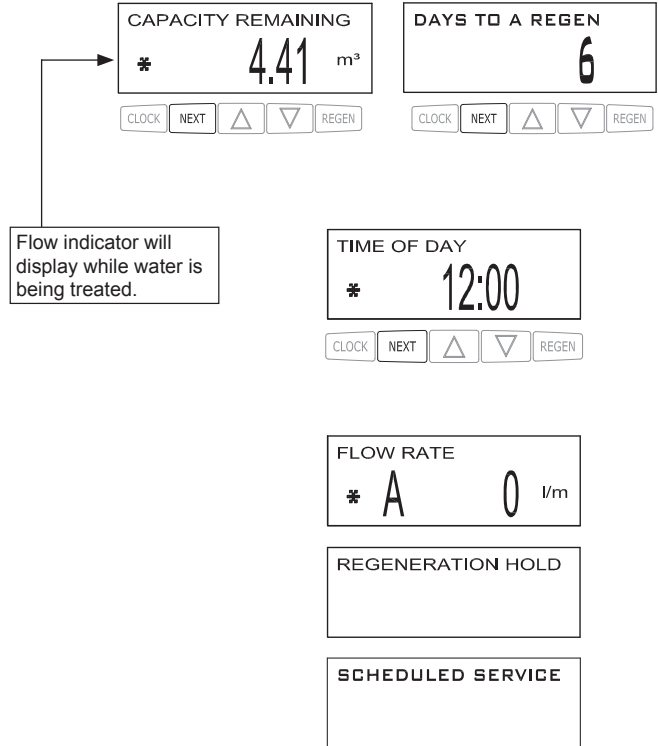

REGEN PENDING will be displayed in Alternator Systems whenever a unit is waiting to initiate the first cycle step of regeneration.



STAND BY will be displayed in Alternator Systems when a valve is in Standby state.



DELAYED RINSE+FILL PENDING will be displayed whenever a zero-capacity tank has transferred to an off-line state and is currently waiting to initiate the second portion of a regeneration cycle. Viewed only when Delayed Rinse and Fill is set to ON.

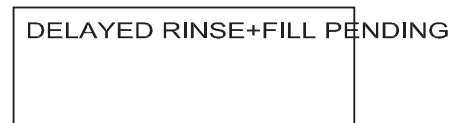

Regeneration Mode

Typically a system is set to regenerate at a time of low water usage. An example of a time with low water usage is when a household is asleep. If there is a demand for water when the system is regenerating, untreated water will be used.

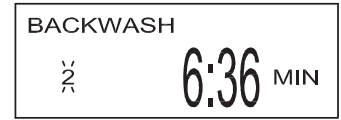

When the system begins to regenerate, the display will change to include information about the step of the regeneration process and the time remaining for that step to be completed. The system runs through the steps automatically and will reset itself to provide treated water when the regeneration has been completed.

Manual Regeneration

Sometimes there is a need to regenerate the system sooner than when the system calls for it, usually referred to as manual regeneration. There may be a period of heavy water usage because of guests or a heavy laundry day.

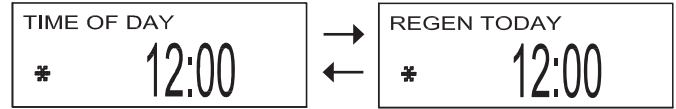

To initiate a manual regeneration at the preset delayed regeneration time, when the regeneration time option is set to “DELAYED REGEN” or “BOTH”, press and release “REGEN”. The words “REGEN TODAY” will periodically be shown on the display to indicate that the system will regenerate at the preset delayed regeneration time. If you pressed the “REGEN” button in error, pressing the button again will cancel the request. Note: If the regeneration time option is set to “IMMEDIATE” there is no set delayed regeneration time so “REGEN TODAY” will not activate if “REGEN” button is pressed.

To initiate a manual regeneration immediately, press and hold the “REGEN” button for three seconds. The system will begin to regenerate immediately. The request cannot be cancelled.

Note: For softeners, if brine tank does not contain salt, fill with salt and wait at least two hours before regenerating.

Set Time of Day

The user can also set the time of day. Time of day should only need to be set if the battery has been depleted because of extended power outages or when daylight saving time begins or ends. If an extended power outage occurs, the time of day will flash on and off which indicates the time of day should be reset. The non rechargeable battery should also be replaced.

STEP 1U

STEP 1U – Press CLOCK.



STEP 2U

STEP 2U - Current Time (hour): Set the hour of the day using ▼ or ▲. Press NEXT to go to Step 3U.



STEP 3U

STEP 3U - Current Time (minutes): Set the minutes of the day using ▼ or ▲. Press NEXT to exit Set Time of Day. Press REGEN to return to previous step.



RETURN TO NORMAL MODE

Power Loss

If the power goes out the system will keep time until the battery is depleted. If an extended power outage occurs, the time of day will flash on and off which indicates the time of day should be reset and the non rechargeable battery replaced. The system will remember the rest.

Error Message

If the word "ERROR" and a number are displayed contact the OEM for help. This indicates that the valve was not able to function properly. If the number and banner text in the Contact Screens has been edited, the two displays below will alternate.

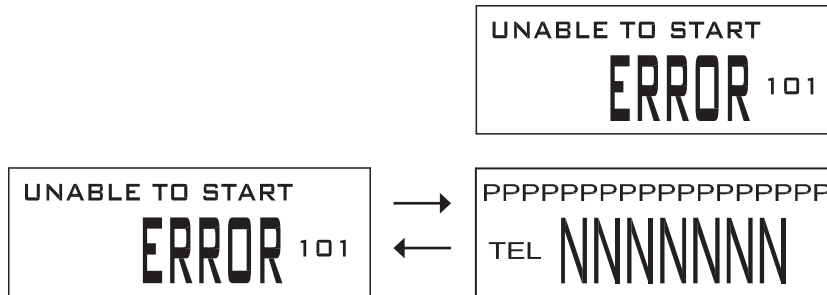

Diagnostics

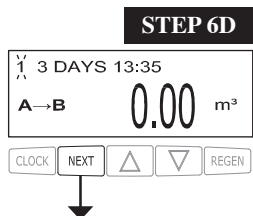
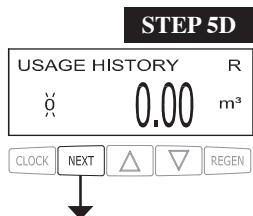
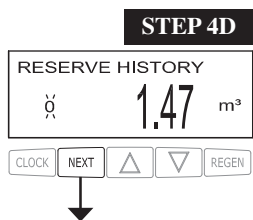
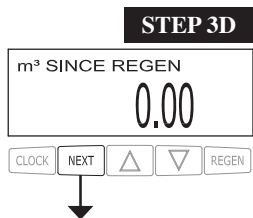
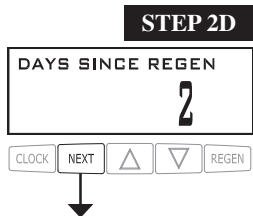
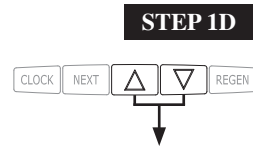

STEP 1D – Press ▲ and ▼ simultaneously for three seconds. If screen in step 2D does not appear in 5 seconds the lock on the valve is activated. To unlock press ▼, NEXT, ▲, and CLOCK in sequence, then press ▲ and ▼ simultaneously for 3 seconds.

STEP 2D – Days, since last regeneration: This display shows the days since the last regeneration occurred. Press NEXT to go to Step 3D. Press REGEN to exit Diagnostics.

STEP 3D – Volume, since last regeneration: This display shows the volume of water that has been treated since the last regeneration. This display will equal zero if a water meter is not installed. Press NEXT to go to Step 4D. Press REGEN to return to previous step.

STEP 4D – Reserve History Volume used for last 7 days: If the valve is set up as a softener, a meter is installed and Set Volume Capacity is set to “Auto,” this display shows 0 day (for today) and the reserve capacity. Pressing ▲ will show day 1 (which would be yesterday) and the reserve capacity used. Pressing ▲ again will show day 2 (the day before yesterday) and the reserve capacity. Keep pressing ▲ to show the capacity for days 3, 4, 5 and 6. ▼ can be pressed to move backwards in the day series. This screen is not displayed if filter, time clock, meter immediate, alternator or volume override regeneration is selected. Press NEXT at any time to go to Step 5D. Press REGEN to return to previous step.

STEP 5D - Volume, 63-day usage history: This display shows day 0 (for today), day 1 (for yesterday), etc., and the volume of water treated that day. Press ▲ to show the volume of water treated for the last 63 days. If a regeneration occurred on the day the letter “R” will also be displayed. This display will show dashes if a water meter is not installed. Press NEXT at any time to go to Step 6D. Press REGEN to return to previous step.

STEP 6D - Tank Transfer History. Only displayed when 1.0TWIN is selected in Step 2CS. Use ▲ or ▼ to scroll through the last 10 tank transfers. “1”= transfer number – 10 transfers maximum. “A” = tank transferring. “3 DAYS” = days ago of transfer – 99 days maximum. “0.00 m³” = M³ used at time of tank transfer. “13:35” = time of transfer. Press NEXT to go to Step 7D. Press REGEN to return to previous step.

STEP 7D

STEP 7D – Flow rate, maximum last seven days: Use ▲ or ▼ to display the maximum flow rate in liters per minute that occurred in each of the last seven days. This display will equal zero if a water meter is not installed. Press NEXT to go to Step 8D. Press REGEN to return to previous step.

STEP 8D

STEP 8D – MAV Drive History: Displays the drive time histories of all active MAV drives. Use ▲ or ▼ to review the history of all active MAV outputs. TTT – measured MAV drive time; VVV – measured MAV drive voltage; CCC – total number of drives (in or out); “+” indicates piston drive out of MAV; “-“ indicates piston drive in to MAV. If a MAV is replaced, it is recommended that the diagnostics screen for that MAV be cleared. That is done by selecting the + or – screen for that MAV. Press and hold ▲ and ▼ for about 3 seconds. Failure to do this may result in inconsistent MAV operation.

RETURN TO NORMAL MODE

When a MAV error occurs, the Drive History will automatically be reset. To view previously recorded history, press and hold CLOCK and ▲. The display will be similar to the normal MAV drive history display, with the addition of EEE – MAV error code present at the time of reset. If the display shows “---”, there was no MAV error before the reset.

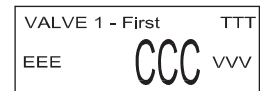

Press NEXT to exit Diagnostics. Press REGEN to return to previous step.

When desired, all programming and information in Diagnostics may be reset to defaults when the valve is installed in a new location. To reset to defaults, press NEXT and ▼ simultaneously to go to the Auto/Manual screen. Press ▲ and ▼ simultaneously to reset programming and diagnostic values to defaults. Screen will return to User Display.

Valve History

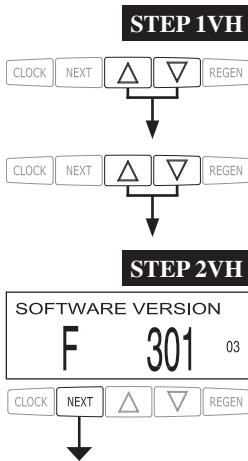

STEP 1VH – Press ▲ and ▼ simultaneously for three seconds and release. Then press ▲ and ▼ simultaneously and release. If screen in step 2VH does not appear in 5 seconds the lock on the valve is activated. To unlock press ▼, NEXT, ▲, and CLOCK in sequence, then press ▲ and ▼ simultaneously for 3 seconds and release. Then press ▲ and ▼ simultaneously and release.

STEP 2VH – Software version. Displays the current software version. Press NEXT to go to Step 3VH. Press REGEN to exit Valve History.

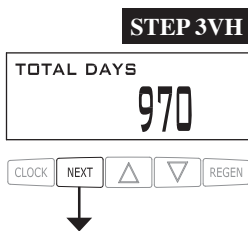

STEP 3VH² – Days, total since start-up: This display shows the total days since startup. Press NEXT to go to Step 4VH. Press REGEN to return to previous step.

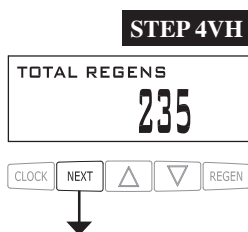

STEP 4VH – Regenerations, total number since start-up: This display shows the total number of regenerations that have occurred since startup. Press NEXT to go to Step 5VH. Press REGEN to return to previous step.

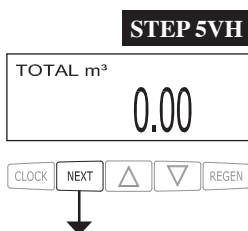

STEP 5VH – Volume, total used since start-up: This display shows the total cubic meters treated since startup. This display will equal zero if a water meter is not installed. Press NEXT to go to Step 6VH. Press REGEN to return to previous step.

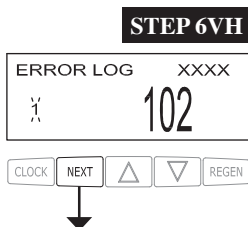

STEP 6VH – Error Log. This display shows a history of the last 10 errors generated by the control during operation. The motor position count at the time of drive error detection is recorded in the top line of the display. Press ▲ or ▼ to view each error recorded. Press NEXT to exit Valve History. Press REGEN to return to previous step.

RETURN TO NORMAL MODE

² Values in steps 2VH through 6VH cannot be reset.

Revision History:**10/10/2018****PAGE 4:**

Update Power Supply information

4/23/2020**PAGE 4:**

Removed #7 V3106-01 from table and drawing.

Not Shown	V3186EU-06	WS1 POWER SUPPLY EU 15VDC HOCP	1
-----------	------------	--------------------------------	---

9/14/2021**PAGE 4:**

Updated PCB part number and drawing

PAGE 6:

Updated Table 1

PAGE 8:

Updated Steps 4SS and 5SS

PAGE 9:

Updated Step 8SS

PAGE 14:

Updated Step 12CS

PAGE 16:

Updated Setting Options Table

PAGE 23:

Updated Software Version