

Water Specialist PI Disc Control Valve Programming Manual

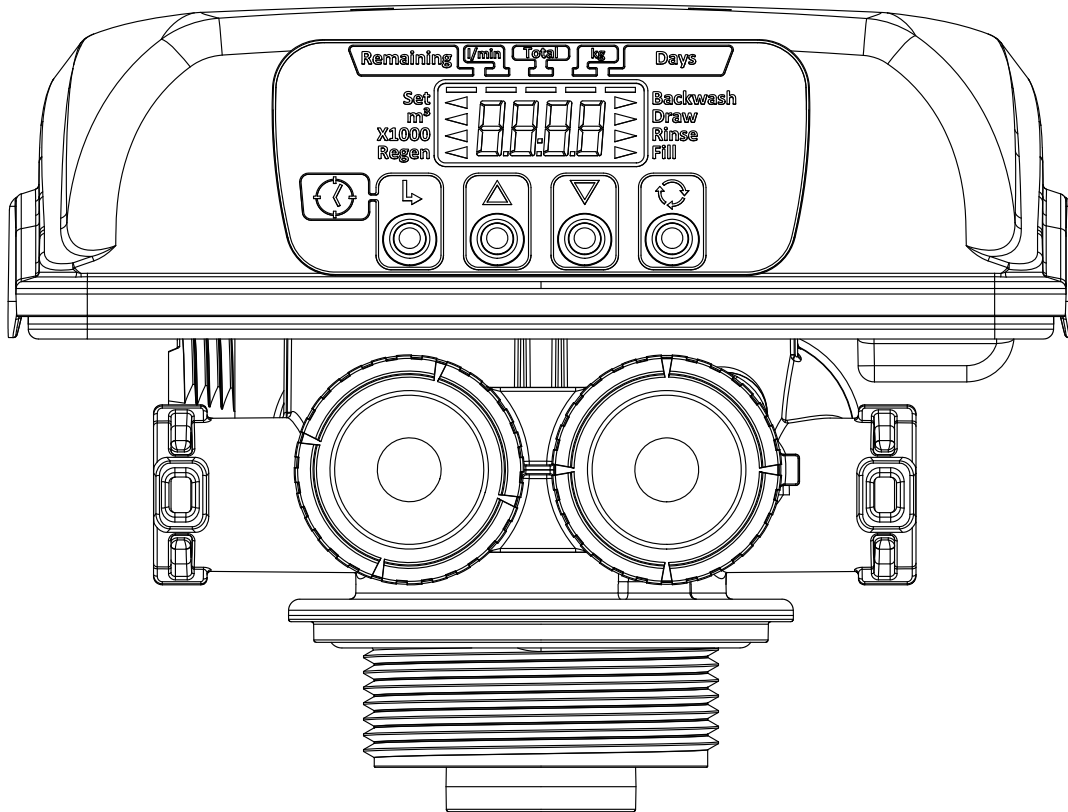

Operation and Instruction Manual for OEM Only.

Please Note: This operation and instruction manual is for the training of the OEM and for the OEM to use to train their customers. This document is not to be used as the complete system manual.

Table of Contents

Introduction.....	4
OEM General Instructions	5
Button Operation and Function.....	5
Control Valve Function and Cycles of Operation	6
Setting Options Table.....	7
User Screens.....	8
Set Time of Day	9
OEM Softener System Setup	10
OEM Filter System Setup	12
OEM Installer Settings.....	14
Diagnostics.....	15
Front Cover and Drive Assembly	18

Introduction

This fully automatic control valve is designed as the primary control center to direct and regulate all cycles of a water softener or filter. When the control valve is manufactured as a softener, the control valve can be ordered to perform downflow or upflow regeneration. When the control valve is set up as a filter, the control valve can be set to perform downflow regeneration or simply backwash. The control valve can be set to regenerate on demand (consumption of a predetermined amount of water) and/or as a time clock (passage of a set number of days). The control valve can be set so that a softener can meet the Water Quality Association (WQA) Standard S100 or NSF/ANSI Standard 44 efficiency rating.

The control valve is compatible with a variety of regenerants and resin cleaners. The control valve is capable of routing the flow of water in the necessary paths to regenerate or backwash water treatment systems. The injector regulates the flow of brine or other regenerants. The control valve regulates the flow rates for backwashing, rinsing, and replenishing treated water into a regenerant tank, when applicable.

The control valve uses no traditional fasteners (i.e., screws); instead, clips, threaded caps, nuts, and snap type latches are used. Caps and nuts only need to be firmly hand tightened because radial seals are used. Tools required to service the valve include one small blade screwdriver, one large blade screwdriver, and a pair of hands. A plastic wrench is available which eliminates the need for screwdrivers and pliers. Disassembly for servicing takes much less time than comparable products currently on the market. Control valve installation is made easy because the distributor tube can be cut up to 1/2" below the top of the tank thread. The distributor tube is held in place by an O-ring seal, and the control valve also has a bayonet lock feature for upper distributor baskets.

OEM General Instructions

The control valve offers multiple procedures that allow the valve to be modified to suit the needs of the installation. These procedures are:

- OEM Softener System Setup
- OEM Filter System Setup
- Installer Displays & Settings
- User Displays
- Diagnostics

These procedures can be accessed in any order. Details on each of the procedures are provided below and on the following pages.

When in operation, User Displays show the time of day or days remaining before regeneration. When stepping through a procedure, if no buttons are pressed within 5 minutes, the display returns to the User Display. Any changes made prior to the 5 minute time-out are incorporated.

To re-initialize the control valve, check to make sure the control is in User Display. Then, simultaneously press NEXT and REGEN or unplug power source plug on the circuit board, wait approximately 3 seconds, and plug back in.

Button Operation and Function



OR

UP or DOWN: Either button changes the value of the setting being viewed.



NEXT: 1. Moves to the next display.
2. While viewing Time of Day, press and hold for 3 seconds to change the time of day



REGEN: 1. Toggles a manually initiated delayed regeneration on or off.
2. Holding for more than 3 seconds forces an immediate regeneration.
3. Moves back one display while in programming mode.
4. Pressing during regeneration immediately advances the valve to the next regeneration cycle step.



AND



Re-homes valve, displays the software version, and resets a manually initiated regeneration request.



Key sequence to lock and unlock software. With software locked, User and Installer levels may still be viewed and set as desired.

Control Valve Function and Cycles of Operation

Cycle Sequence/Adjustable Cycle Default Times (minutes)									
System Type	Fill Type	Draw Type	Fill	Service	Backwash	Draw	Backwash	Rinse	Fill
Soft	Post	Down			8	60	8	8	4.25 kg
Soft	Pre	Down	4.25 kg	240	8	60	8	8	
Soft	Post	Up				60	8	8	4.25 kg
Soft	Pre	Up	4.25 kg	240		60	8	8	
FLT1	N/A	N/A			8			4	
FLT2	Post	Down			8	60	8	8	4.20 l

The control valve with a water meter can be set for the following:

- Demand Initiated Regeneration (DIR) only
- Time Clock operation only
- DIR and/or Time Clock (whichever occurs first), depending upon what settings are selected for Day Override and Volume Capacity

See Setting Options Table.

If a control valve does not contain a meter, the valve can only act as a time clock, and Day Override should be set to any number and Volume Capacity should be set to *OFF*.

Reserve Capacity is automatically estimated based on water usage if rES is used.

If a specific Volume Capacity is set, reserve capacity is zero.

The control valves can be set to regenerate immediately or at the next regeneration time by changing the Regeneration Type Option (Step 4S). There are 3 choices for settings:

1. *dELY* means regeneration will occur at the preset regeneration time.
2. *on 0* means regeneration will occur when the volume capacity reaches zero.
3. *rES* means the regeneration will occur at the preset regeneration time when the calculated reserve amount has been reached.

The user can initiate manual regeneration. The user has the option to request the manual regeneration at the delayed regeneration time or to have the regeneration occur immediately:

1. Press and release REGEN. The regeneration annunciator will flash on the display and the regeneration will occur at the delayed regeneration time. The user can cancel the request by pressing and releasing REGEN.

Note: This method of manually initiating regeneration is NOT allowed when the Regeneration Type is set to *on 0*.

2. Press and hold REGEN for approximately 3 seconds to immediately start the regeneration. The user cannot cancel this request, except by resetting the control by pressing NEXT and REGEN simultaneously for 3 seconds.

Proportional Brining:

If the system is set up as a pre-fill upflow softener, the control valve can also be set to normal or proportional brining.

This step will appear after Step 7S and before Step 8S if the system is set up appropriately. The following options can be selected:

- *STd*—System always pre-fills with the salt level selected.
- *ProP*—If proportional brining is selected, the actual salt fill time will be calculated by dividing the actual volume of treated water used by the full volumetric capacity, then multiplying this value by the maximum salt fill time.

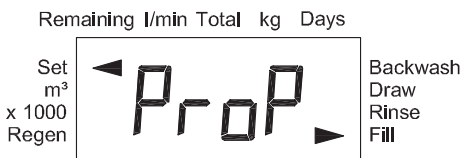

Setting Options Table

System Type	Regeneration Option	Capacity	Day Override	
Soft	rES	0.10–200 kg	1–28 days	Regeneration occurs at the next regeneration time when volume capacity falls below the reserve capacity or the specified number of days is reached, whichever comes first.
Soft	rES	0.10–200 kg	OFF	Regeneration occurs at the next regeneration time when volume capacity falls below the reserve capacity.
Soft	dELY	0.02–5700 m ³	1–28 days	Regeneration occurs at the next regeneration time when volume capacity reaches 0 or the specified number of days is reached, whichever comes first.
Soft	dELY	0.02–5700 m ³	OFF	Regeneration occurs at the next regeneration time when volume capacity reaches 0.
Soft	dELY	OFF	1–28 days	Time Clock operation. Regeneration occurs at the next regeneration time the specified number of days is reached.
Soft	on 0	0.02–5700 m ³	1–28 days	Regeneration occurs immediately when volume capacity reaches 0 or the specified number of days is reached, whichever comes first.
Soft	on 0	0.02–5700 m ³	OFF	Regeneration occurs immediately when volume capacity reaches 0.
FLT1	dELY	0.02–5700 m ³	1–28 days	Regeneration occurs at the next regeneration time when volume capacity reaches 0 or the specified number of days is reached, whichever comes first.
FLT1	on 0	0.02–5700 m ³	OFF	Regeneration occurs immediately when volume capacity reaches 0.
FLT2	dELY	0.02–5700 m ³	1–28 days	Regeneration occurs at the next regeneration time when volume capacity reaches 0 or the specified number of days is reached, whichever comes first.
FLT2	on 0	0.02–5700 m ³	OFF	Regeneration occurs immediately when volume capacity reaches 0.

User Screens

Remaining I/min Total kg Days

Set m³ x 1000 Regen



Backwash
Draw
Rinse
Fill

Time of day.

Remaining I/min Total kg Days

Set m³ x 1000 Regen



Backwash
Draw
Rinse
Fill

Volume remaining until regeneration.

Remaining I/min Total kg Days

Set m³ x 1000 Regen



Backwash
Draw
Rinse
Fill

Number of days until the next regeneration.

Remaining I/min Total kg Days

Set m³ x 1000 Regen



Backwash
Draw
Rinse
Fill

Current flow rate in lpm. Flow rate bar will flash when water is flowing.

Remaining I/min Total kg Days

Set m³ x 1000 Regen



Backwash
Draw
Rinse
Fill

Display of the error code for the type of failure detected by the control.

Code	Description of Error
101	Unable to start; motor output energized but no movement
102	Valve motor stalled; unable to find proper park position
103	Valve motor ran too long; unable to find proper park position
104	Valve unable to find home position

Remaining I/min Total kg Days

Set m³ x 1000 Regen



Backwash
Draw
Rinse
Fill

Display shown when programming is locked.

Remaining I/min Total kg Days

Set m³ x 1000 Regen



Backwash
Draw
Rinse
Fill

Display shown when programming is unlocked.

Set Time of Day



From the Time of Day display, press and hold NEXT until the SET indicator and the hour flash.



Use ▲ or ▼ to set the hour.
Press NEXT to go to the next display. Press REGEN to exit Set Time of Day.



Use ▲ or ▼ to set the minutes.
Press NEXT to exit Set Time of Day. Press REGEN to return to previous step.

**RETURN TO
NORMAL
MODE**

OEM Softener System Setup

STEP 1S

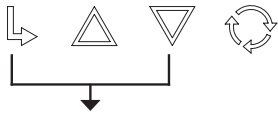

Step 1S – From the User Display, press ▼ and NEXT simultaneously for about 3 seconds and release. If the screen in Step 2S does not appear in 5 seconds, the lock on the valve is activated. To unlock, press ▼, NEXT, ▲, and REGEN in sequence, and try again.

STEP 2S

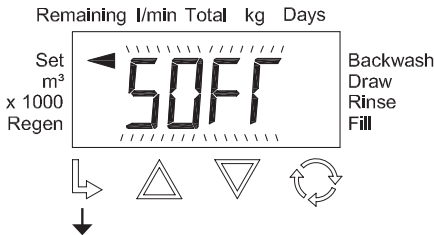

Step 2S – Set System Type to *SOFT* using ▲ or ▼. Press NEXT to go to Step 3S. Press REGEN to exit OEM System Setup.

STEP 3S

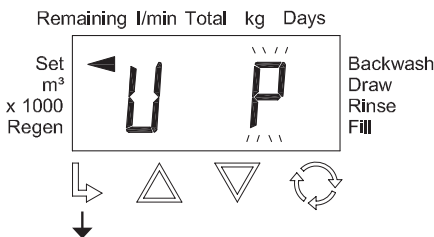

Step 3S – Select Hardness Unit using ▲ or ▼. If value is set to:

- *P*, the unit will be PPM.
- *FH*, the unit will be °fH.
- *dH*, the unit will be °dH.

Press NEXT to go to Step 4S. Press REGEN to return to previous step.

STEP 4S

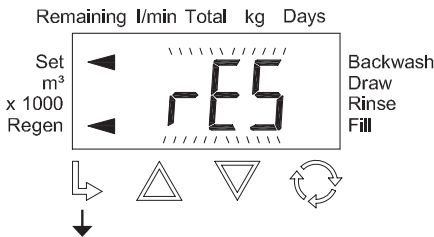

Step 4S – Select Regeneration Type using ▲ or ▼. If value is set to:

- *rES*, regeneration will be delayed with variable reserve until the time of day set in Step 5I and Step 6I.
- *dELY*, regeneration will be delayed until the time of day set in Step 5I and Step 6I.
- *on 0*, regeneration will occur immediately when capacity remaining reaches zero.

Press NEXT to go to Step 5S. Press REGEN to return to previous step.

STEP 5S

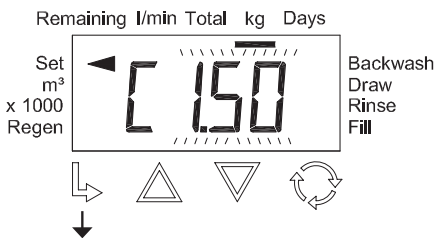

Step 5S – If Step 4S is set to *rES*, set Ionic Capacity using ▲ or ▼. If Step 4S is set to *dELY* or *on 0*, set Volume Capacity. Volume Capacity can be set to 0.02 m³ – 5700 m³ or *OFF*. Press NEXT to go to Step 6S. Press REGEN to return to previous step.



Setting	Units
PPM	kg of CaCO ₃
dH or FH	m ³

STEP 6S

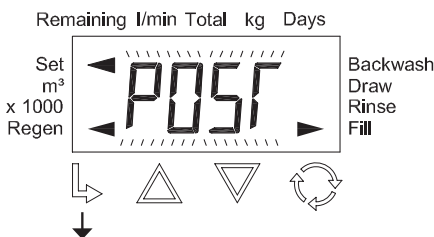

Step 6S – Set Fill Type to *POST* or *PrE* using ▲ or ▼. Press NEXT to go to Step 7S. Press REGEN to return to previous step.

STEP 7S

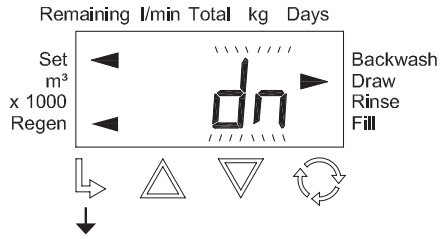

Step 7S – Set Regenerant Draw Type to *dn* or *UP* using ▲ or ▼. Press NEXT to go to Step 8S. Press REGEN to return to previous step.

Note: The following displays can differ depending on system type and fill type. See Control Valve Function and Cycles of Operation for more detail.

STEP 8S

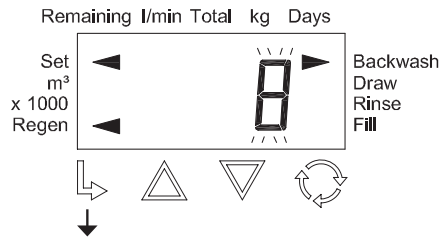

Step 8S – Set the length of the backwash to 1 – 95 minutes or *OFF* using ▲ or ▼. Press NEXT to go to Step 9S. Press REGEN to return to previous step.

STEP 9S

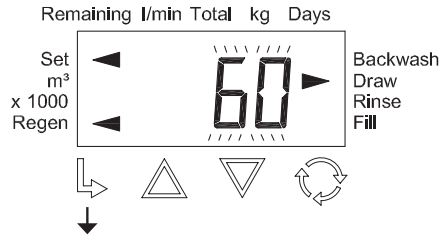

Step 9S – Set the length of the regenerant draw to 1 – 180 minutes or *OFF* using ▲ or ▼. Press NEXT to go to Step 10S. Press REGEN to return to previous step.

STEP 10S

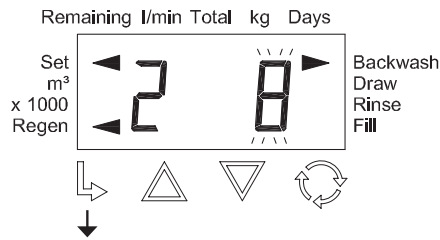

Step 10S – Set the length of the second backwash to 1 – 95 minutes or *OFF* using ▲ or ▼. Press NEXT to go to Step 11S. Press REGEN to return to previous step.

STEP 11S

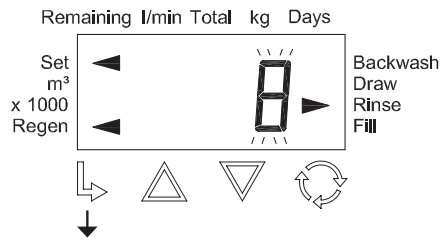

Step 11S – Set the length of rinse to 1 – 95 minutes or *OFF* using ▲ or ▼. Press NEXT to go to Step 12S. Press REGEN to return to previous step.

STEP 12S

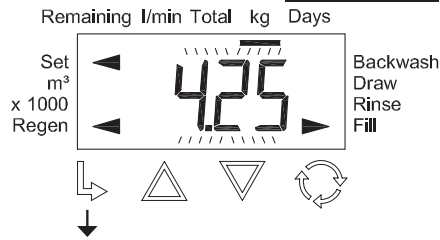

Step 12S – Set the length of fill to 0.05 – 90.0 kg of NaCl or *OFF* using ▲ or ▼. Press NEXT to exit OEM Softener System Setup. Press REGEN to return to previous step.

RETURN TO NORMAL MODE

OEM Filter System Setup

STEP 1F

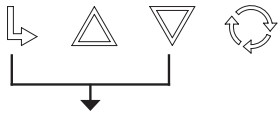

Step 1F – From the User Display, press ▼ and NEXT simultaneously for about 3 seconds and release. If the screen in Step 2F does not appear in 5 seconds, the lock on the valve is activated. To unlock, press ▼, NEXT, ▲, and REGEN in sequence, and try again.

STEP 2F

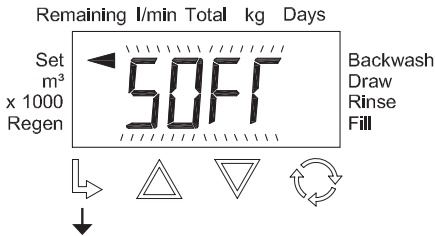

Step 2F – Select Filter System Type using ▲ or ▼. If value is set to:
 • *FLT1*, only filter settings for Backwash and Rinse are viewed.
 • *FLT2*, only filter related regeneration settings are viewed.
 Press NEXT to go to Step 3F. Press REGEN to exit OEM System Setup.

STEP 3F

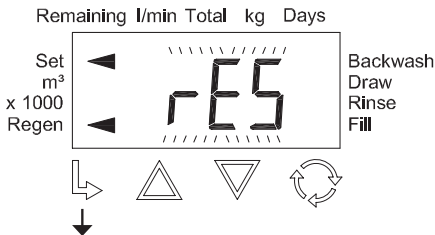

Step 3F – Select Regeneration Type using ▲ or ▼. If value is set to:
 • *dELY*, regeneration will be delayed until the time of day set in Step 5I and Step 6I.
 • *on 0*, regeneration will occur immediately when capacity remaining reaches zero.
 Press NEXT to go to Step 4F. Press REGEN to return to previous step.

STEP 4F

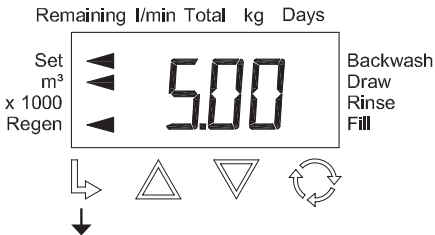

Step 4F – Set Volume Capacity using ▲ or ▼. Volume Capacity can be set to 0.02 m³–5700 m³ or *OFF*.
 Press NEXT to go to Step 5F. Press REGEN to return to previous step.

Note: The following displays can differ depending on system type and fill type. See Control Valve Function and Cycles of Operation for more detail.

STEP 5F

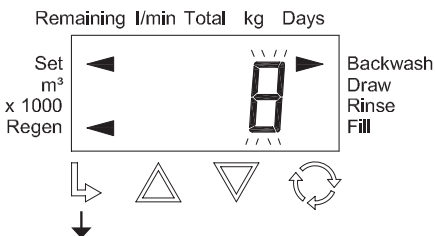

Step 5F – Set the length of the backwash to 1 – 95 minutes or *OFF* using ▲ or ▼.
 Press NEXT to go to Step 6F. Press REGEN to return to previous step.

STEP 6F

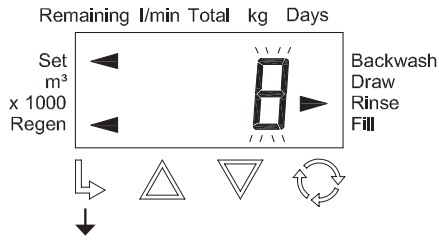

Step 6F – Set the length of rinse to 1 – 95 minutes or *OFF* using ▲ or ▼. Press NEXT to go to Step 7F. Press REGEN to return to previous step.

STEP 7F

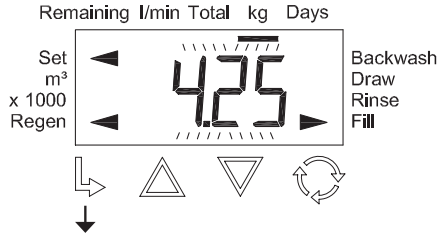

Step 7F – Set the length of fill from 0.05 – 90.0 kg of NaCl or *OFF* using ▲ or ▼. Press NEXT to exit OEM Filter System Setup. Press REGEN to return to previous step.

RETURN TO NORMAL MODE

OEM Installer Settings

STEP 1I



Step 1I – From the User Display, press ▲ and NEXT simultaneously for about 3 seconds and release.

STEP 2I



Step 2I – Set the Inlet Water Hardness using ▲ or ▼. The unit on this display will vary depending on the selection made in Step 3S. This screen will only appear if Step 4S is set to *rES*.

Press NEXT to go to Step 3I. Press REGEN to exit OEM Installer Settings.

STEP 3I

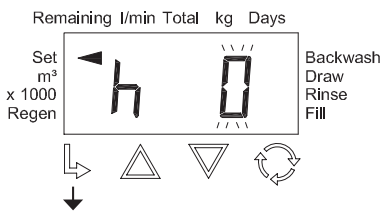

Step 3I – Service Water Hardness (PPM): If a mixing valve is installed in the valve, service hardness needs to be set. Setting range is always less than the setting in Step 2I. This screen will only appear if Step 4S is set to *rES*.

Press NEXT to go to Step 4I. Press REGEN to return to previous step.

STEP 4I

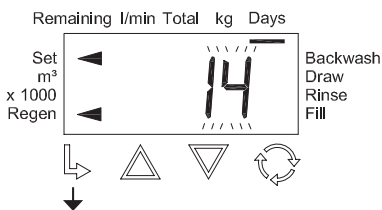

Step 4I – Set Day Override to 1 – 28 days or *OFF* using ▲ or ▼.

Press NEXT to go to Step 5I. Press REGEN to return to previous step.

STEP 5I

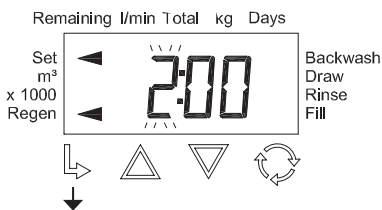

Step 5I – Time of Regeneration, Hour: Set the time (hour) for regeneration using ▲ or ▼. The default time is 2:00 a.m. This display will show *on 0* if Step 4S or Step 3F is set to *on 0*.

Press NEXT to go to Step 6I. Press REGEN to return to previous step.

STEP 6I

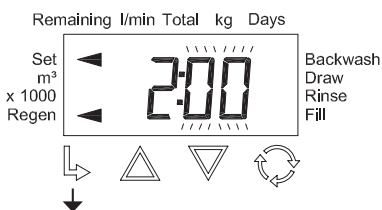

Step 6I – Time of Regeneration, Minutes: Set the time (minutes) for regeneration using ▲ or ▼. The default time is 2:00 a.m. This display will not appear if Step 4S or Step 3F is set to *on 0*.

Press NEXT to go to Step 7I. Press REGEN to return to previous step.

STEP 7I

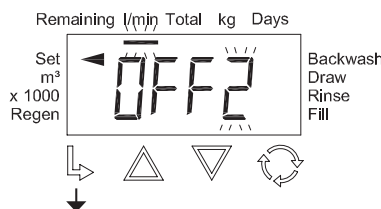
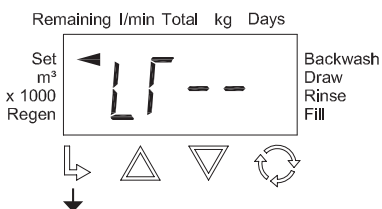

Step 7I – Backlight Operation: Set the normal activity of the LCD backlight using ▲ or ▼. If value is set to:

- *On*, the backlight is always on.
- *Off1*, the backlight turns off after 5 minutes of no activity.
- *Off2 + l/min*, the backlight turns off after 5 minutes of no activity except with water flow detection.

Press NEXT to exit Installer Settings. Press REGEN to return to previous step.

RETURN TO NORMAL MODE

Diagnostics

STEP 1D

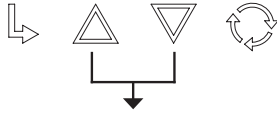

Step 1D – From the User Display, press ▲ and ▼ simultaneously for 3 seconds and release. If the screen in Step 2D does not appear in 5 seconds, the lock on the valve is activated. To unlock, press ▼, NEXT, ▲, and REGEN in sequence, and try again.

STEP 2D

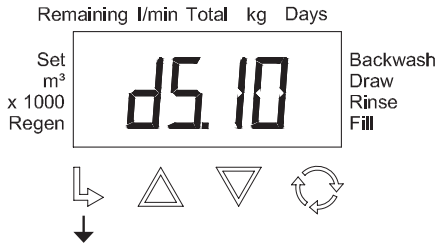

Step 2D – Software version.
Press NEXT to go to Step 3D. Press REGEN to exit Diagnostics.

STEP 3D

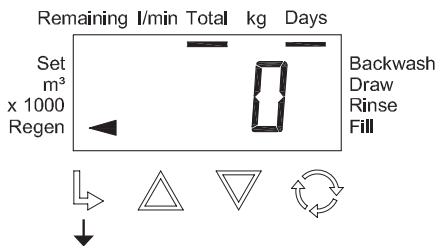

Step 3D – Days Since Last Regeneration.
Press NEXT to go to Step 4D. Press REGEN to return to previous step.

STEP 4D

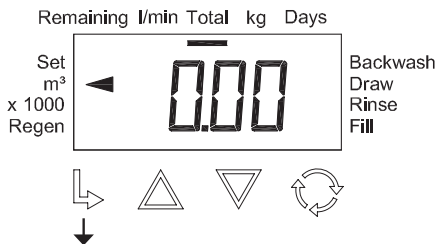

Step 4D – Volume Used Since Last Regeneration.
Press NEXT to go to Step 5D. Press REGEN to return to previous step.

STEP 5D

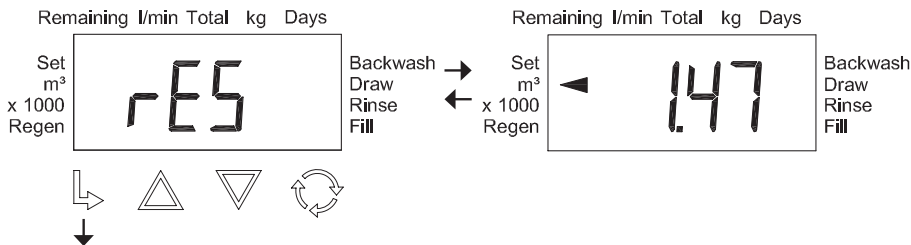

Step 5D – Reserve Capacity: Displays the actual reserve capacity calculated for yesterday. This screen will only appear if Step 4S or Step 3F is set to rES. Press NEXT to go to Step 6D. Press REGEN to return to previous step.

STEP 6D

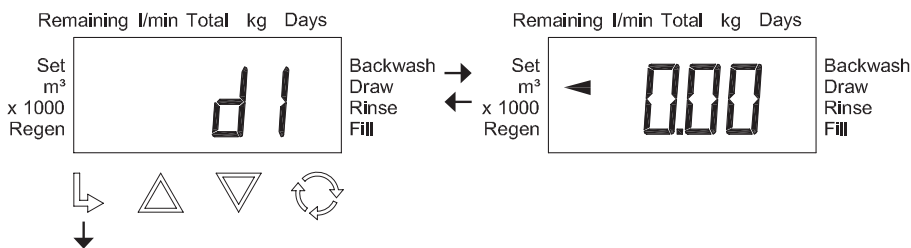

Step 6D – Treated Water Usage: Displays the volume of treated water per day for the past 63 days. REGEN indicator is activated for days on which a regeneration occurred. d0 is today, d1 is yesterday, etc. Press NEXT to go to Step 7D. Press REGEN to return to previous step.

STEP 7D

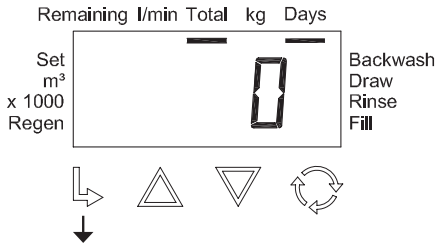

Step 7D – Total Days in Service.

Press NEXT to go to Step 8D. Press REGEN to return to previous step.

STEP 8D

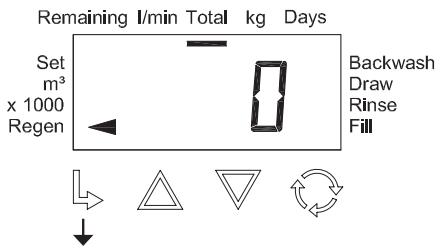

Step 8D – Total Regenerations.

Press NEXT to go to Step 9D. Press REGEN to return to previous step.

STEP 9D

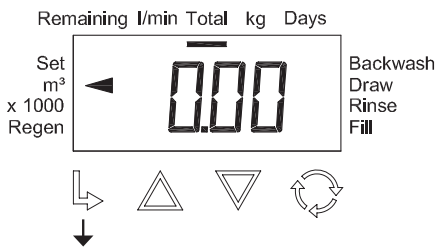

Step 9D – Total Volume of Treated Water since display was last reset. This display can be reset by pressing and holding ▼ for about 3 seconds.

Press NEXT to go to Step 10D. Press REGEN to return to previous step.

STEP 10D

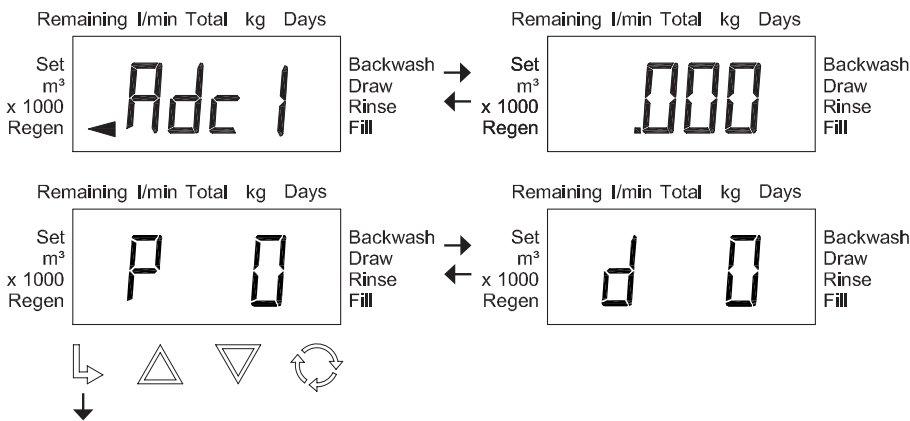

Step 10D – Motor Drive Current History:

During each regeneration cycle, the valve motor current (Adc) is monitored and the maximum value is then logged in this display upon regeneration completion. The first display is the regeneration record number; the second display is the current measurement made during that regeneration; the third display is the disc position count at the time of measurement; the fourth display is how many days since the initial day of operation that this measurement was made.

Press NEXT to go to Step 11D. Press REGEN to return to previous step.

STEP 11D

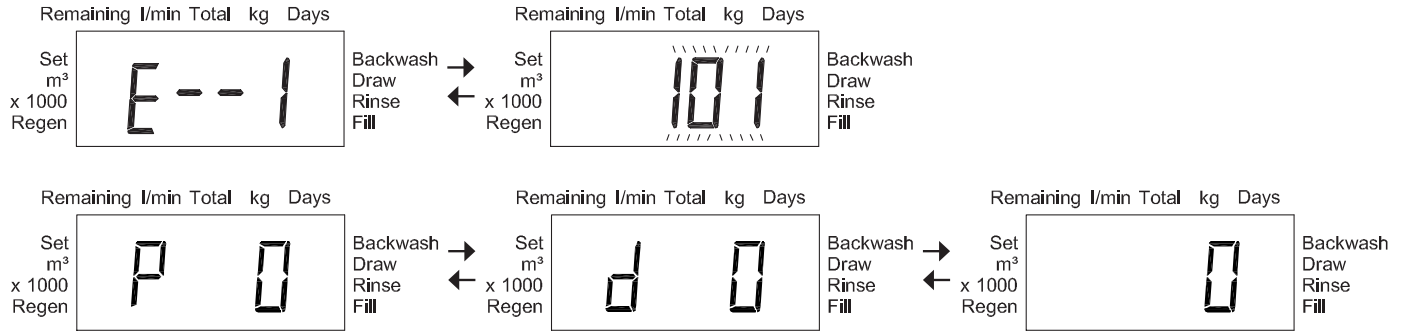

↓

RETURN TO NORMAL MODE

Step 11D – Error Log: Displays a history of the last 10 valve errors generated by the control. The third display is the disc position count; the fourth display is how many days since the initial startup that this error was detected; the fifth display contains the active status codes regarding the motor drive at the time of error detection. Displays 3 – 5 only appear with 101 – 104 errors.

Code	Description of Error
101	Unable to start; motor output energized but no movement
102	Valve motor stalled; unable to find proper park position
103	Valve motor ran too long; unable to find proper park position
104	Valve unable to find home position

PI Front Cover and Drive Assembly

Drawing No.	Order No.	Description	Quantity
1	V4114	DV BACKPLATE	1
2	V4115	DV MAIN DRIVE GEAR	1
3	V4235	DV REDUCTION GEAR 9X48	1
4	V4116	DV ENCODER WHEEL	1
5	V4012	T1/DV DRIVE GEAR AXLE	1
6	V4117	DV REDUCTION GEAR AXLE	3
7	V4195	DV REDUCTION GEAR 12X48	3
8	V4133-02	DV MOTOR ASY MOLEX W/PINION	1
9	V4129	DV SPRING CLIP	1
10	V4123PI-03BOARD	DV PI BACKLIGHT 20POS PCB REPL	1
11	V4128	DV ENCODER GUIDE RIGHT	1
12	V4127	DV ENCODER GUIDE LEFT	1
13	V4118-01	DV DRIVE BRACKET ASY	1
14	V4119-01W	DV FRONT COVER METRIC ASY WHITE	1

Note: No. 1, 6, 8, and 9 can be ordered as V4243.

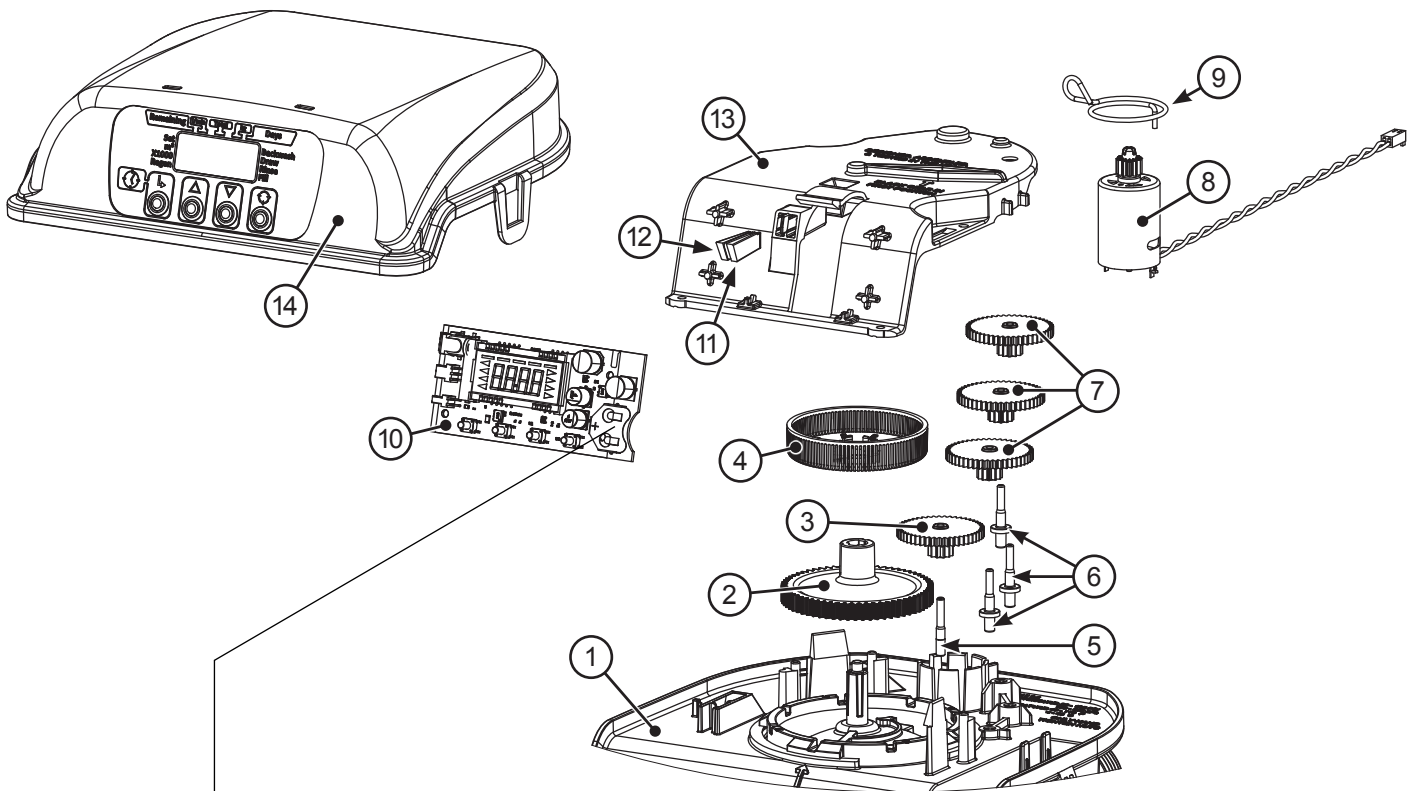

When replacing the battery, align positives and push down to fully seat.

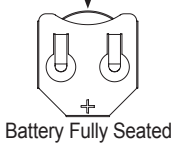

Correct Battery Orientation

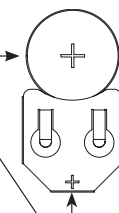

Battery replacement is 3 volt lithium coin cell type 2032.

Revision History:

1/11/2020

PAGE 16:

Updated Step 10D

2/18/2021

PAGE 19:

Updated drawing

5/15/2023

VARIOUS:

Moved part or all of following sections to Water Specialist Disc Control Valve Drawings and Service Manual:

- Introduction
- Specifications
- Internal Components
- Injector Cap, Injector Screen, Injector, Plug, and O-Ring
- Injector Order Information
- Refill Flow Control Assembly and Refill Port Plug
- Drain Line
- Water Meter
- Installation Fitting Assemblies
- Bypass Valve
- Flow Diagrams
- Service Spanner Wrenches

Split OEM System Setup into OEM Softener System Setup and OEM Filter System Setup

Various grammatical and formatting changes throughout

PAGE 6:

FLT2	Post	Down			8	60	8	8	4.20 1
------	------	------	--	--	---	----	---	---	--------

PAGE 15:

Step 2D - new display

PAGE 18:

9	V4129	DV SPRING CLIP	1
---	-------	----------------	---

Updated drawing.

